

ANSWERS

Unit 1

1. (d) 2. (b) 3. (a) 4. (d) 5. (a) 6. (a)
7. (a) 8. (c) 9. (b) 10. (b) 11. (a) 12. (c)
13. (b) 14. (d) 15. (a) 16. (a) 17. (b) 18. (d)
19. (d) 20. (a) 21. (a) 22. (a) 23. (d) 24. (a)
25. (b) 26. $\frac{45}{63}$ 27. $\frac{35}{45}$ 28. $\frac{35}{40}$
29. positive rational number 30. negative rational number
31. no 32. 1, -1 33. x^2 34. $\frac{-45}{8}$ or $-5\frac{5}{8}$
35. $(657)^{-1}$ 36. -1 37. $\frac{a}{b} \times \frac{c}{d} + \frac{a}{b} \times \frac{e}{f}$
38. more 39. infinitely many 40. opposite
41. positive 42. order 43. $\frac{-7}{5}$ 44. $\frac{3}{4}$
45. $\frac{1011}{100}$ 46. $\frac{1}{5} \times \frac{3}{8}$ 47. -3 -4 48. False
49. False 50. True 51. True 52. False 53. True 54. True
55. True 56. False 57. False 58. True 59. False 60. False
61. False 62. False 63. True 64. True 65. False 66. False
67. True 68. False 69. False 70. False 71. False 72. False
73. False 74. False 75. True 76. False 77. False 78. False

- 79.** False **80.** True **81.** False **82.** False **83.** True **84.** False
85. False **86.** False **87.** False **88.** True **89.** True **90.** True
91. True **92.** True **93.** True **94.** False **95.** True **96.** True
97. False **98.** True **99.** True
- 100.** $\frac{8}{4}, \frac{9}{3}, \frac{6}{3}, \frac{4}{2}, \frac{1}{1}, \frac{0}{1}, \frac{-1}{1}, \frac{-2}{1}, \frac{-4}{2}, \frac{-6}{2}$ **101.** $\frac{64}{16}, \frac{36}{-12}, \frac{5}{-4}, \frac{140}{28}$
- 102.** a) $\frac{-8}{9}$ b) $\frac{-256}{35}$ **106.** (a) $\frac{25}{8}$ (b) $\frac{-4}{75}$ (c) $\frac{17}{70}$ (distributive law)
- 107.** Associative property
- 111.** (a) $6\frac{7}{8}$ (b) $-3\frac{1}{3}$ (c) $\frac{-11}{8}$ or $-1\frac{3}{8}$ (d) $\frac{-88}{3}$ or $-29\frac{1}{3}$
- 112.** (a) $\frac{142}{15}$ or $9\frac{7}{15}$ (b) $\frac{2}{7}$ (c) $\frac{32}{63}$ (d) $\frac{41}{48}$
- 113.** $\frac{-7}{3}$ as it is smaller than -1 whereas rest of the numbers are greater than -1
- 114.** Rs 18 **115.** 85 km/h **116.** $\frac{3}{2}$ m or 1.5m
- 117.** Rs. 77,000 **118.** 16 pieces **119.** 28 **120.** 1920
- 121.** Rs 864, Rs 720, Rs 432
- 122.** Rs 32,000, Rs 12,000, Rs 16,000
- 123.** Associative and commutative property.
- 124.** (i) Commutative property.
 (ii) Distributive property of multiplication over addition.
 (iii) Associative property.
 (iv) Additive identity of rational number.
 (v) Multiplicative identity of rational number.
- 125.** (i) $\frac{-8}{9}$ (ii) $\frac{3}{10}$ **126.** $\frac{13}{16} > \frac{5}{8} > \frac{1}{4}$
- 127.** $\frac{-2}{3}$ **128.** $\frac{20}{21}$ **129.** -39 **130.** $\frac{7}{5}$
- 131.** No. **132.** $\frac{1}{6}, \frac{2}{6}, \frac{3}{6}, \frac{4}{6}, \frac{5}{6}$ **133.** $\frac{1}{5}$ and $\frac{-1}{5}$

134. 12 135. $\frac{11}{24}$ m 136. $\frac{8}{7} > \frac{2}{5} > 0 > \frac{-9}{8} > \frac{-3}{2}$
137. (i) 0 (ii) $\frac{1}{2}$ 138. 3.2°F 139. $\frac{-48}{7}$ or $-6\frac{6}{7}$
140. -1 141. a) $\frac{19}{10}$ m b) $\frac{209}{100}$ m
142. 7; $\frac{75}{32}$ sqm or $2\frac{11}{32}$ sqcm 143. $\frac{3}{8}$ cup
144. a) $\frac{3}{160}$ km b) $\frac{13}{200}$ km c) Nancy
145. a) $58\frac{1}{2}$ km b) $117\frac{1}{3}$ km
146. (a) Less than (b) Paper Glass
(c) More $\frac{1}{2}$ (d) Paper > Glass > Scrap > Aluminium cans
147. $97\frac{7}{25}$ cm, $98\frac{4}{9}$ cm, $98\frac{1}{25}$ cm, $97\frac{47}{50}$ cm
 $97\frac{7}{25}$ cm < $97\frac{47}{50}$ cm < $98\frac{1}{25}$ cm < $98\frac{4}{9}$ cm 148. $\frac{2}{5}$ m
149. May : $2\frac{1731}{2500}$, June : $\frac{381}{625}$, July : $-6\frac{568}{625}$, August : $-8\frac{159}{250}$
150. AP : $\frac{616}{10}$ $\frac{308}{5}$, Assam : $\frac{571}{10}$, Bihar : $\frac{607}{10}$,
Gujarat : $\frac{619}{10}$, Haryana : $\frac{641}{10}$, HP : $\frac{651}{10}$,
Karnataka : $\frac{624}{10} = \frac{312}{5}$, Kerala : $\frac{706}{10} = \frac{353}{5}$, MP : $\frac{565}{10} = \frac{113}{2}$,
Maharashtra : $\frac{645}{10} = \frac{129}{2}$, Orissa : $\frac{576}{10} = \frac{288}{5}$, Punjab : $\frac{669}{10}$

Rajasthan : $\frac{598}{10} = \frac{299}{5}$, Tamil Nadu : $\frac{637}{10}$, U.P. : $\frac{589}{10}$,

West Bengal : $\frac{628}{10} = \frac{314}{5}$

Kerala; Punjab; HP; Maharashtra; Haryana; Tamil Nadu; West Bengal; Karnataka; Gujarat; Andhra Pradesh; Bihar; Rajasthan; UP; Orissa; Assam; MP.

152. 39 cm **153.** Manavi : Rs 315, Kuber : Rs 84

(D) Games and Puzzles

1.

$\frac{32}{38}$	$\frac{18}{38}$	$\frac{4}{38}$	$\frac{-14}{-38}$
$\frac{-18}{-57}$	$\frac{-21}{-133}$	$\frac{24}{38}$	$\frac{104}{152}$
$\frac{22}{38}$	$\frac{70}{95}$	$\frac{25}{95}$	$\frac{-20}{-95}$
$\frac{1}{19}$	$\frac{-16}{-38}$	$\frac{45}{57}$	$\frac{60}{114}$

2.

Down 1: Rational
 Down 3: Commutative
 Down 5: Indefinitely
 Down 7: 1
 Across 1: infinite
 Across 3: Multiplication
 Across 5: Not defined

Down 2: Additive
 Down 4: Reciprocal (or Inverse)
 Down 6: Division
 Down 8: Number
 Across 2: Associative
 Across 4: Natural
 Across 6: Inverse

3. Riddle

S.No. Lowest Term

Word

(1) $\frac{2}{5}$

S(P)IN

(2) $\frac{2}{3}$

T(Y)PE

(3) $\frac{3}{4}$

WI(T)H

S.No. Lowest Term

Word

(4) $\frac{-1}{3}$

(H)OST

(5) $\frac{3}{10}$

SH(A)RP

(6) $\frac{1}{5}$

(G)AIN

3. Riddle

S.No.	Lowest Term	Word	S.No.	Lowest Term	Word
(7)	$\frac{4}{5}$	PROOF	(9)	$\frac{1}{4}$	AWAY
(8)	$\frac{-1}{2}$	RAIN	(10)	$\frac{-1}{3}$	SWEET

P Y T H A G O R A S
 (1) (2) (3) (4) (5) (6) (7) (8) (9) (10)

4.

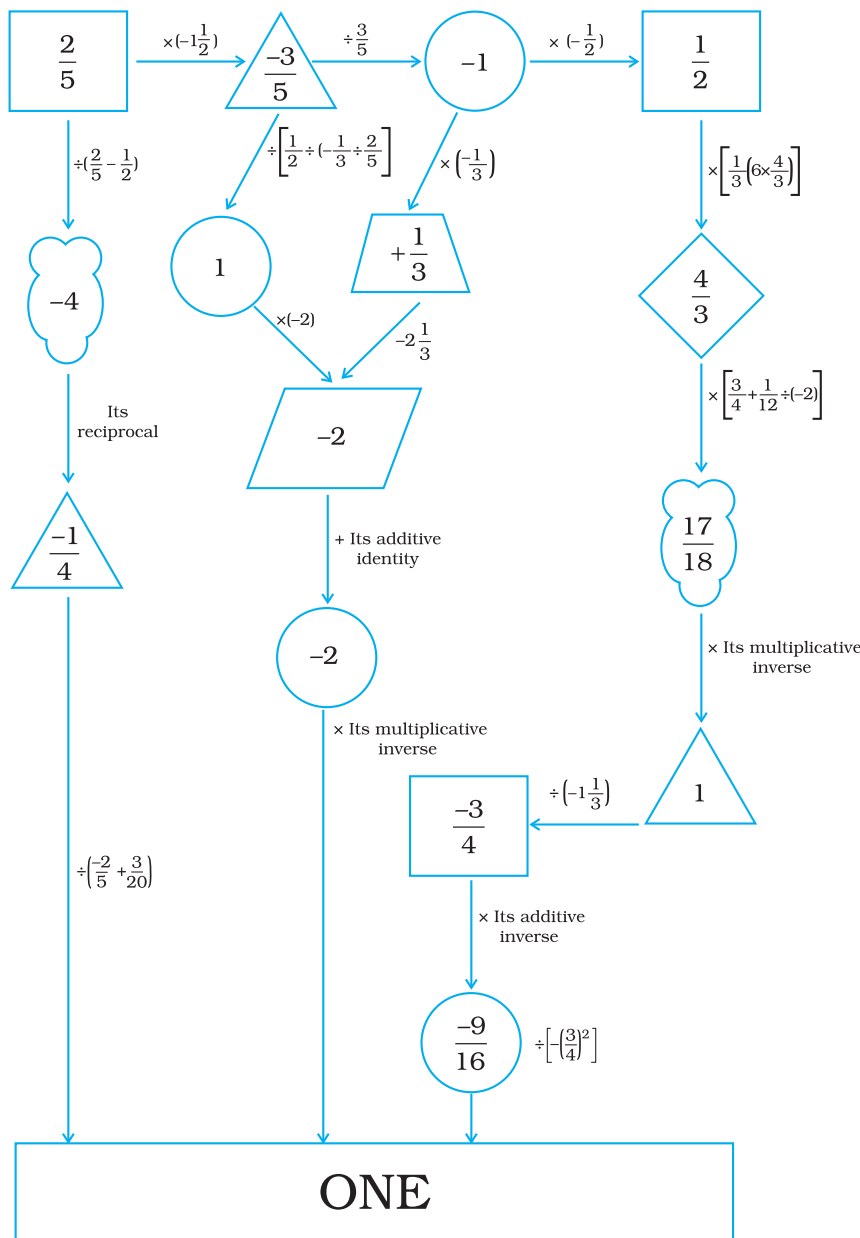

Unit 2

- 1.** (d) **2.** (a) **3.** (b) **4.** (c) **5.** (d) **6.** (b)
7. (b) **8.** (c) **9.** (c) **10.** (d) **11.** (b) **12.** (c)
13. (d) **14.** (d) **15.** (b) **16.** (c) **17.** (b) **18.** (a)
19. (a) **20.** (d) **21.** (d) **22.** (b) **23.** (b) **24.** (d)
25. (d) **26.** (c) **27.** (d) **28.** (d) **29.** (c) **30.** (d)
31. (c) **32.** (b) **33.** (d) **34.** (d) **35.** (c) **36.** Raw
37. 20 **38.** Upper class limit **39.** 19 **40.** Parts
41. Head, tail **42.** 1, 2, 3, 4, 5, 6 **43.** event
44. Random **45.** Size/Width **46.** 35-40
47. 40 **48.** 8 **49.** 22 **50.** 14 **51.** Frequency
52. Class Intervals **53.** 2 **54.** 5 **55.** Bars **56.** likely
57. X, Y **58.** 20-30 **59.** True **60.** False **61.** True **62.** True
63. True **64.** True **65.** True **66.** False **67.** True **68.** True
69. False **70.** False **71.** True **72.** False **73.** True **74.** False
75. False **76.** True **77.** False **78.** False **79.** True **80.** False
81. False **82.** a) 20 b) 60 c) 4 d) 20-30 e) 30-40 f) 10
84. a) 329 b) 168 c) 301 d) 2 hours or more
85. a) Bus b) $\frac{1}{4}$ c) 72 d) 6 e) car and Walk
86. a) $\frac{1}{2}$ b) $\frac{1}{6}$ c) $\frac{2}{6}$ or $\frac{1}{3}$ d) 0 e) $\frac{5}{6}$ f) $\frac{4}{6}$ or $\frac{2}{3}$
87. a) Certain to happen (b) May or may not happen
c) Certain to happen (d) Impossible to happen
e) Impossible to happen (f) May or may not happen
88. Mathematics 180, English 135, Social Science 30
Science 105, Hindi 90 **89.** 28
90. (a) 42 (b) 150-155 (c) 5 (d) 28

91.

Class interval	Tally marks	Frequency
0 - 2		0
2 - 4	≡	6
4 - 6	≡	6
6 - 8	≡ ≡	11
8 - 10		2
	Total	25

92.

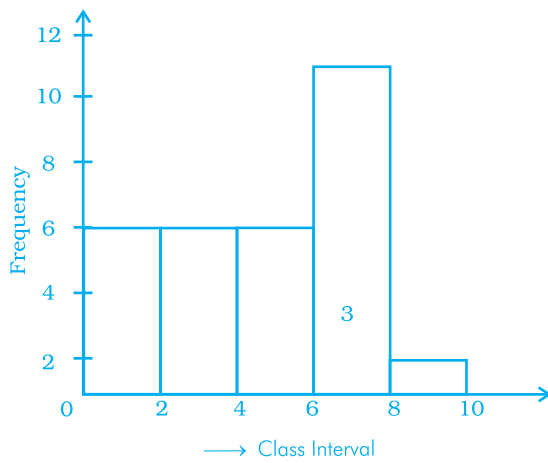

93.

Class interval	Tally marks	Frequency
4 - 8		2
8 - 12	≡	8
12 - 16	≡ ≡	13
16 - 20	≡	5
20 - 24		2
	Total	30

94.

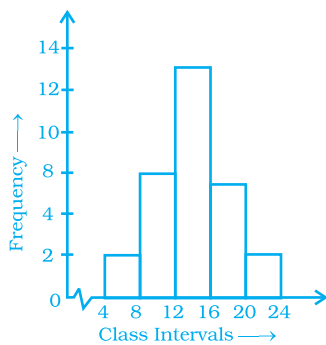

95. Class interval	Tally marks	Frequency
25 - 30		2
30 - 35		8
35 - 40		10
40 - 45		7
45 - 50		3
	Total	30

- a) 25 - 30 b) 35 - 40

96.

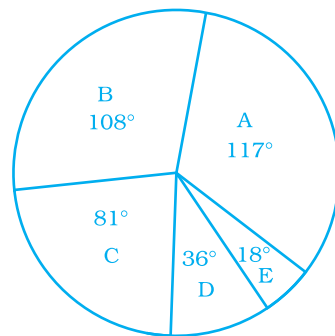

97. (i) 1 Crore
 (ii) 2.5 times
 (iii) $\frac{3}{10}$

98.

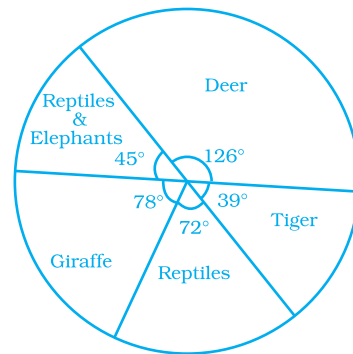

99. (a) $\frac{1}{8}$
 (b) $\frac{4}{16}, \frac{4}{16}$

100.

Class interval	Tally marks	Frequency
30 – 35		3
35 – 40		3
40 – 45		3
45 – 50		3
50 – 55	≇	5
55 – 60		4
60 – 65	≇	5
65 – 70		2
70 – 75	≇	7
	Total	35

a) 9

b) 70 - 75

101. 12, 14, 06, 2, 1

102.

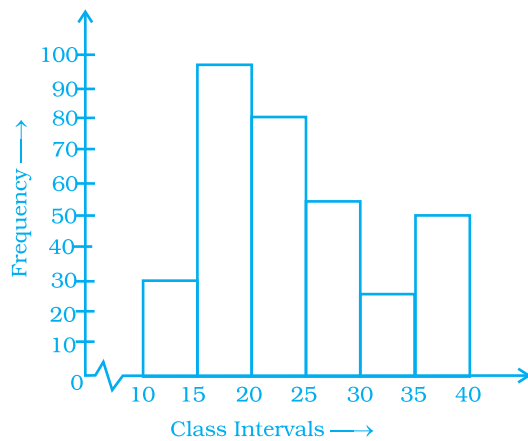

103.

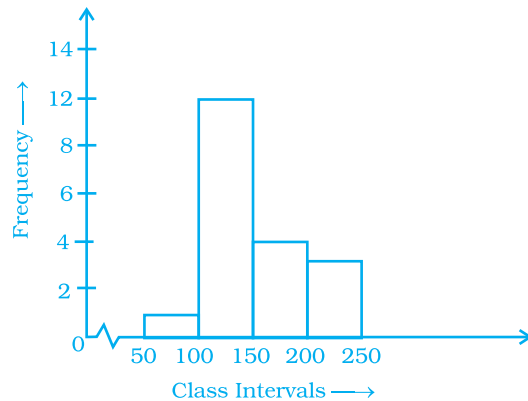

- 104.** a) 10-15, 15-20, 20-25, 25-30, 30-35, 35-40
 b) 5
 c) 10-15
 d) 15-20

- 105.** a) 5
 b) maximum experience 2, minimum experiences 5
 c) 9

106.

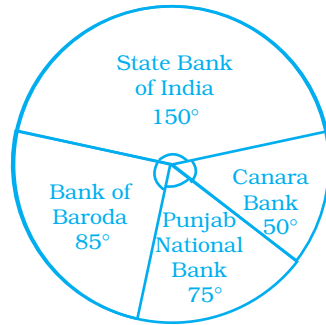

107.

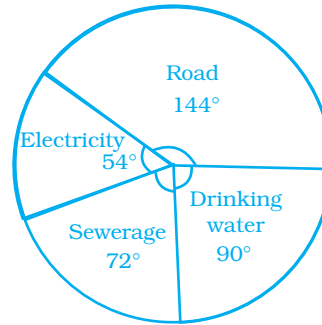

108.

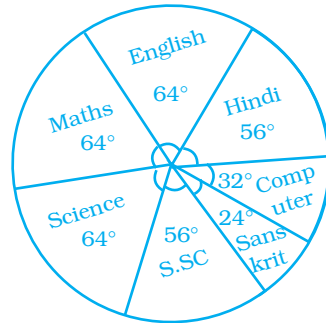

109.

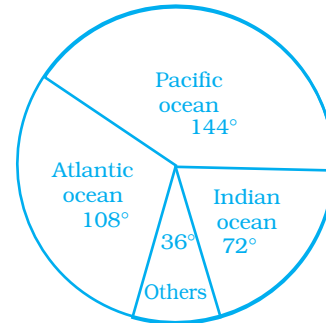

- 110.** (i) Cold drinks
 (ii) 300

- 111.** a) $\frac{1}{4}$ b) $\frac{3}{8}$ c) $\frac{7}{8}$

- 112.** a) $\frac{1}{2}$ b) $\frac{3}{10}$ c) $\frac{1}{10}$ d) 0

- 113.** a) 32% ☁️ b) 28% ⬠️ c) 22% + d) 18% ⬠️

- 114.** a) 32% 🍦_{Red} b) 38% 🍦_{Yellow} c) 30% 🍦_{Pink}

115. Housing	-Rs 15,000
Food	-Rs 10,000
Car loan	-Rs 12,500
Utilities	-Rs 5,000
Phone	-Rs 2,500
Clothing	-Rs 2,500
Entertainment	-Rs 2,500

- 116.** a) Newspaper
 b) Radio
 c) 39%
 d) 63%
 e) Internet, Webmedia

(D) Application, Games and Puzzles

(I)	K	Q	J	10	9	8	7	6	5	4	3	2	A	Total
Spade	1	1	1	1	1	1	1	1	1	1	1	1	1	13
Heart	1	1	1	1	1	1	1	1	1	1	1	1	1	13
Diamond	1	1	1	1	1	1	1	1	1	1	1	1	1	13
Club	1	1	1	1	1	1	1	1	1	1	1	1	1	13
														52

1) 2 2) 52 3) 13 4) 4 Spade, Heart, Diamond, Club

5) 26 6) 26 7) 3 of each type 8) 12

9) (i) $\frac{6}{52}$ or $\frac{3}{26}$ (ii) $\frac{2}{52}$ or $\frac{1}{26}$ (iii) $\frac{1}{52}$

(iv) $\frac{12}{52}$ or $\frac{6}{26}$ or $\frac{3}{13}$ (v) $\frac{2}{52}$ or $\frac{1}{26}$ (vi) $\frac{2}{52}$ or $\frac{1}{26}$

(vii) 1 (viii) $\frac{3}{52}$ (ix) $\frac{1}{52}$

(x) $\frac{4}{52}$ or $\frac{1}{13}$ (xi) $\frac{13}{52}$ or $\frac{1}{4}$ (xii) $\frac{1}{2}$

(II) (a)

Outcomes	Sum	Outcomes	Sum	Outcomes	Sum
(1, 5)	6	(4, 1)	5	(6, 3)	9
(1, 6)	7	(4, 2)	6	(6, 4)	10
(2, 1)	3	(4, 3)	7	(6, 5)	11
(2, 2)	4	(4, 4)	8	(6, 6)	12
(2, 3)	5	(4, 5)	9		
(2, 4)	6	(4, 6)	10		
(2, 5)	7	(5, 1)	6		
(2, 6)	8	(5, 2)	7		
(3, 1)	4	(5, 3)	8		
(3, 2)	5	(5, 4)	9		
(3, 3)	6	(5, 5)	10		
(3, 4)	7	(5, 6)	11		
(3, 5)	8	(6, 1)	7		
(3, 6)	9	(6, 2)	8		

(b)

Sum of Dots	Tally Marks	No. of Outcomes	Probability
1	0	0	0
2	I	1	$\frac{1}{36}$
3	II	2	$\frac{1}{18}$
4	III	3	$\frac{1}{12}$
5	IIII	4	$\frac{1}{9}$
6	Ǝ	5	$\frac{5}{36}$
7	Ǝ I	6	$\frac{1}{6}$
8	Ǝ	5	$\frac{5}{36}$
9	IIII	4	$\frac{1}{9}$

10		2	$\frac{1}{12}$
11		2	$\frac{1}{18}$
12		1	$\frac{1}{36}$

- (III) 1. A ~~|||||~~
 B |
 C ~~|||~~
 D ~~||||~~
 E ~~|||||~~
 F ~~|||~~
 G ~~|~~
 H ~~||||~~
 I ~~|||~~
 J
 K
 L ~~||~~
 M ~~||~~
 N ~~|||~~
 O ~~||||~~
 P ~~|~~
 Q
 R ~~|||~~
 S ~~|||~~
 T ~~|||~~
 U ~~|||~~
 V ||||
 W |
 X |
 Y |
 Z |

MATHEMATICS

2. 2 letters		20
3 letters		18
4 letters		18
5 letters		08
6 letters		09
more than 6 letters		33
		<hr/> 106 <hr/>

Crossword Answers

Across

- Pie Chart
- Five
- Range
- Event
- Whole
- One
- Equal

Down

- Histogram
- Raw
- Class Size
- Frequency
- Zero

Unit 3

- | | | | | | |
|---------|---------|---------|---------|---------|---------|
| 1. (c) | 2. (a) | 3. (c) | 4. (d) | 5. (b) | 6. (c) |
| 7. (b) | 8. (b) | 9. (c) | 10. (b) | 11. (b) | 12. (b) |
| 13. (b) | 14. (a) | 15. (b) | 16. (d) | 17. (b) | 18. (b) |
| 19. (a) | 20. (d) | 21. (b) | 22. (a) | 23. (c) | 24. (d) |

- 25.** 8 **26.** 8 **27.** 6 **28.** 4 **29.** $2n$ **30.** 3
31. 30.25 **32.** 5.3 **33.** 6 **34.** 10000 **35.** 1000000
36. 2 **37.** 0.49 **38.** 36 **39.** 9 **40.** 8, 15 **41.** 1.4
42. 1.728 **43.** odd **44.** $\sqrt[3]{x}$ or $x^{1/3}$ **45.** 5 **46.** 2
47. 2 **48.** 3 **49.** True **50.** False **51.** True **52.** True
53. False **54.** True **55.** False **56.** True **57.** False **58.** False
59. False **60.** False **61.** True **62.** True **63.** False **64.** False
65. False **66.** False **67.** False **68.** False **69.** True **70.** False
71. False **72.** True **73.** True **74.** False **75.** True **76.** False
77. False **78.** False **79.** True **80.** True **81.** False **82.** False
83. False **84.** False **85.** False **86.** False **87.** 1, 4, 9, 16, 25
88. 27, 216, 729 **90.** $1+3+5+7+9+11+13+15+17$
91. a) $484 = \underline{2 \times 2} \times \underline{11 \times 11}$; perfect square
b) $11250 = 2 \times \underline{3 \times 3} \times \underline{5 \times 5} \times \underline{5 \times 5}$; not a perfect square
c) $841 = \underline{29 \times 29}$; a perfect square
d) $729 = \underline{3 \times 3} \times \underline{3 \times 3} \times \underline{3 \times 3}$; a perfect square.
92. a) $128 = \underline{2 \times 2 \times 2} \times 2 \times \underline{2 \times 2 \times 2}$; not a perfect cube
b) $343 = \underline{7 \times 7 \times 7}$; a perfect cube
c) $729 = \underline{3 \times 3 \times 3} \times \underline{3 \times 3 \times 3}$; a perfect cube
d) $1331 = \underline{11 \times 11 \times 11}$; a perfect cube
93. a) $101^2 = 10201$ b) $72^2 = 5184$ **94.** Yes, because $6^2 + 8^2 = 10^2$
95. (3, 4, 5) **96.** a) 105 b) 69 **97.** a) 8 b) 13
98. No, 11 **99.** No, 75 **100.** 3, 4, 5 and 5, 12, 13
101. 6; 6 **102.** 60; 60 **103.** a) 37 b) 75
104. a) 5.2 b) 1.2 **105.** 16; 37
106. 41, 79 **107.** 1024 **108.** 961 **109.** 3600
110. $\sqrt{50}$ or $5\sqrt{2}$ **111.** 7.2 **112.** 9.2 **113.** 22500 m²

MATHEMATICS

- 114.** 16 **115.** 3,375 **116.** 82m **117.** 576 m²
118. 8 cm **119.** 5, 10 and 15 **120.** 42.25 m²
121. 4 **122.** 6 **123.** 32 **124.** 52
125. 104 **126.** 93 **127.** 37 m **128.** 3.3 m
129. 900 **130.** 8, 12, 20 **131.** 3600 **132.** $10\frac{1}{2}$ m
133. 18 **134.** 0.3, 0.45, 0.6 **135.** 3.6
136. 50,653 **137.** 85, 184
138. 8836 **139.** 6, 19, 30 **140.** 104 **141.** 196, 961
142. 12, 21, 102, 201

Cross Number Puzzle

¹ 7	² 3	6	1	⁶ 3
³ 2	⁵ 5	0	0	0
⁴ 9	⁷ 6	¹⁰ 7	1	2
6	2	5	⁹ 3	5
¹¹ 1	5	1	⁸ 6	4

Unit 4

- 1.** (c) **2.** (c) **3.** (c) **4.** (a) **5.** (b) **6.** (c)
7. (a) **8.** (c) **9.** (d) **10.** (a) **11.** (b) **12.** (c)
13. (a) **14.** (d) **15.** (a) **16.** highest **17.** 1
18. $\frac{6}{5}$ **19.** solution **20.** 3 **21.** 3, 4 and 5
22. Rs 16.50 **23.** sign **24.** 10 **25.** - 60 **26.** -24
27. 5 **28.** 7 **29.** 6 years **30.** $4x + 15 = 39$
31. $x + 9$ **32.** 100 **33.** False **34.** False **35.** False **36.** True
37. False **38.** True **39.** False **40.** False **41.** False **42.** False
43. False **44.** True **45.** False **46.** False **47.** False **48.** False

49. $x = 8$ 50. $x = -2$ 51. $x = 7$ 52. $x = \frac{8}{3}$
 53. $x = 0$ 54. $x = \frac{31}{6}$ 55. $y = \frac{17}{22}$ 56. $x = -5$
 57. $x = 2$ 58. $x = 4$ 59. $x = -6$ 60. $t = 0$
 61. $x = 7$ 62. $x = 2$ 63. $x = \frac{-12}{5}$ 64. $x = 11$
 65. $x = \frac{-8}{9}$ 66. $x = 5$ 67. $x = \frac{43}{35}$ 68. $t = 17$
 69. $y = \frac{1}{2}$ 70. $x = 37$ 71. $y = \frac{-37}{57}$ 72. $x = \frac{1}{18}$
 73. $x = \frac{-3}{17}$ 74. $t = \frac{1}{3}$ 75. $m = \frac{7}{5}$ 76. $P = \frac{-5}{22}$
 77. $x = -96$ 78. $x = 18.3$ 79. 24 flowers 80. Rs 4500
 81. 50l, 100l 82. 800 83. 24 84. 18
 85. 23 86. 52 87. 1200 88. 12, 42
 89. 56 90. 9m, 23m, 23m 91. 12 years
 92. Rs 3,00,000 93. $\frac{7}{4}$ 94. 65, 66, 67, 68
 95. $14\frac{1}{3}$ kg 96. $l = 80$ cm, $b = 40$ cm
 97. A = 20 years, B = 15 years 98. $\frac{1}{5}$ 99. 36
 100. 20 days 101. 9 km/hr
 102. 500 Rs notes: 150, 1000 Rs note: 25 103. 15
 104. $\frac{9}{5}$ 105. 10 days 106. 100 107. 11 km/hr
 108. 22 km/hr, 30 km/hr 109. 7 hr 110. $x = 10$ cm
 111. $x = 3$ cm 112. Rs 80, Rs 120 113. 40

Application, Games and Puzzles

1. (a) $x = 3$ (b) $Y = 2$ (c) $Z = 2$ (d) $P = 1$ (e) $Q = 6$ (f) $R = 2$
 2.

$$\begin{array}{l} \diamond + \star = 8 \\ \diamond + \diamond + \star = 10 \\ \diamond + \star + \star + \star + \star = 26 \end{array}$$

3. (c) (i) $x = 6\frac{1}{2}$ (ii) $x = 1$ (iii) $x = 1$ (iv) $\frac{2}{7}$ (v) $x = 60$
 (vi) $x = -5$ (vii) $x = \frac{-7}{5}$ (viii) $x = \frac{24}{5}$ (ix) $x = 5$ (x) $x = 42$
4. (1) $6\frac{1}{2}$ (2) 1 (3) -1 (4) $\frac{2}{7}$ (5) 60
 (6) -5 (7) $-\frac{7}{5}$ (8) $4\frac{4}{5}$ (9) 5 (10) 42
5. 1. Subtraction 2. Equation 3. Distributive
 4. Variable expression 5. Coefficient 6. Multiplication
 7. Equivalent equation 8. Identity 9. Algebra
 10. Standard form 11. Simplified

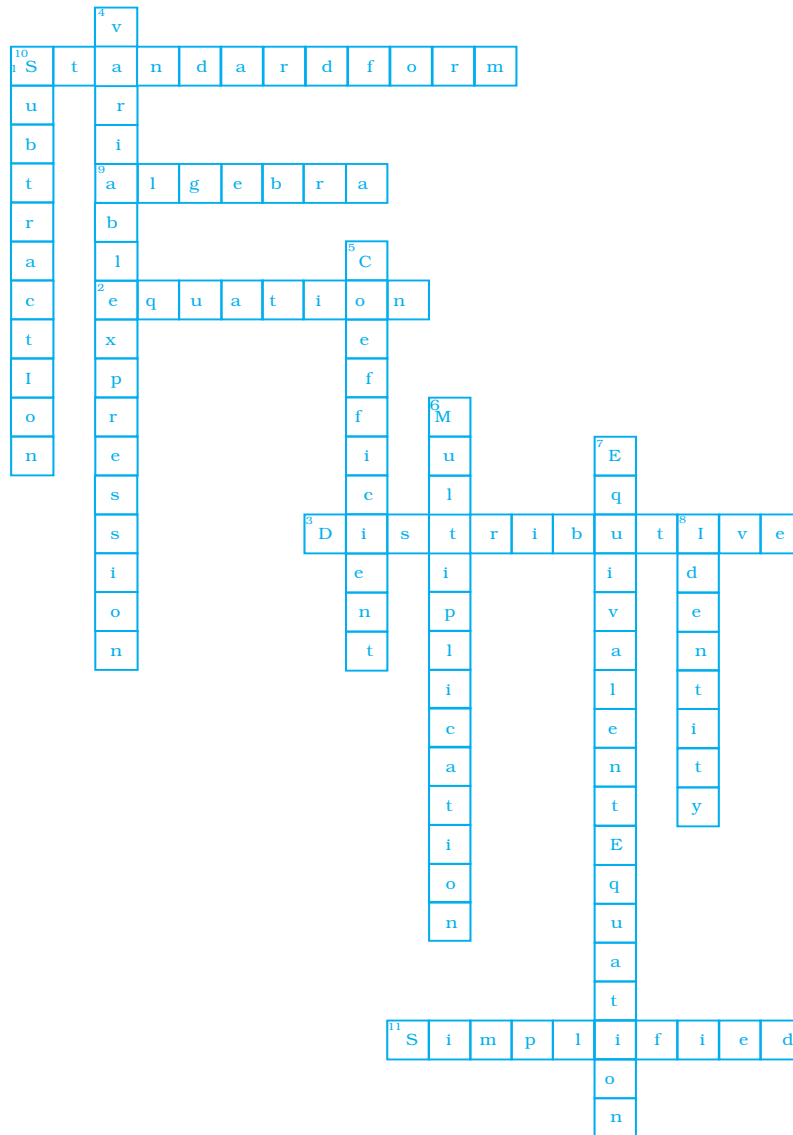

Unit 5

1. (b) 2. (a) 3. (a) 4. (b) 5. (d) 6. (c)
 7. (c) 8. (a) 9. (a) 10. (a) 11. (a) 12. (c)
 13. (b) 14. (c) 15. (d) 16. (a) 17. (a) 18. (a)
 19. (a) 20. (a) 21. (c) 22. (b) 23. (b) 24. (a)
 25. (b) 26. (c) 27. (d) 28. (b) 29. (a) 30. (b)
 31. (a) 32. (d) 33. (a) 34. (b) 35. (a) 36. (c)
 37. (a) 38. (a) 39. (c) 40. (a) 41. (a) 42. (a)
 43. (d) 44. (a) 45. (a) 46. (b) 47. (b) 48. (a)
 49. (c) 50. (c) 51. (b) 52. (c)
 53. HO and EP, PO and EH
 54. RO and OP, OP and PE, PE and ER, ER and RO
 55. $\angle W$ and $\angle Y$, $\angle X$ and $\angle Z$ 56. DF and EG
 57. Angles 58. 72° 59. 720° 60. 20°
 61. 10° 62. Concave Polygon 63. Kite
 64. 108° 65. An equilateral triangle 66. 9
 67. Line segments 68. Angles 69. $2n-4$
 70. 360° 71. Square 72. Trapezium
 73. Rhombus, Square 74. Right 75. 5
 76. 2 included 77. All 78. 1 79. Opposite
 80. 5 81. Parallelogram 82. 28cm 83. 9
 84. Equal 85. Decagon 86. Square 87. 6cm
 88. Supplementary 89. Kite 90. 80°
 91. Quadrilateral 92. False 93. True 94. False
 95. True 96. False 97. False 98. True
 99. True 100. False 101. True 102. True
 103. True 104. False 105. False 106. False
 107. False 108. False 109. False 110. False

- 111.** True **112.** False **113.** False **114.** False
115. False **116.** False **117.** True **118.** True
119. True **120.** True **121.** True **122.** False
123. False **124.** True **125.** False **126.** True
127. True **128.** True **129.** True **130.** True
131. True **132.** 8.5cm **133.** $45^\circ, 135^\circ, 45^\circ, 135^\circ$
134. Trapezium, Others are parallelogram **135.** 2 : 3
136. 36° **137.** No, in a rectangle diagonals are equal.
138. $70^\circ, 110^\circ, 70^\circ, 110^\circ$
139. No, diagonals of a parallelogram bisect each other i.e. in the ratio 1:1.
140. 12 **141.** Parallelogram **142.** Rhombus
143. 23 cm, 30 cm, 30 cm **144.** $30^\circ, 60^\circ, 120^\circ$
145. $55^\circ, 70^\circ, 70^\circ$ **146.** $100^\circ, 80^\circ, 100^\circ$
147. $120^\circ, 60^\circ, 15 \text{ cm}, 11 \text{ cm}, 12 \text{ cm}, 52 \text{ cm}$ **148.** $20^\circ, 20^\circ$
149. $45^\circ, 75^\circ, 35^\circ$ **150.** 70° **151.** 15° each
152. (i)Yes, opposite sides of a rectangle are equal.
(ii)Yes, MY and RX are perpendicular to OE.
(iii)Yes, these are alternate interior angles.
(iv)Yes, $MYO \cong \Delta RXE$
153. $50^\circ, 50^\circ, 50^\circ$ **154.** 120° **155.** 90°
156. $135^\circ, 45^\circ$ **157.** 100° **158.** 2.5 **159.** 90°
160. $x = 2$ **161.** $x = 10^\circ, y = 20^\circ$
162. $x = 80^\circ, y = 110^\circ$ **163.** $x = 80^\circ$
164. 105° each, Parallelogram **165.** 200° , concave
166. 90° **167.** 135°
168. Ext. angle of regular pentagon = $\frac{360^\circ}{5} = 72^\circ$
Ext. angle of regular decagon = $\frac{360^\circ}{10} = 36^\circ$
 $72^\circ = 2 \times 36^\circ$
169. 74° **170.** 80°

171. Yes, $\frac{1}{2}\angle E + \frac{1}{2}\angle P = 180^\circ - \angle PSE \Rightarrow \angle E + \angle P = 360^\circ - 2\angle PSE$

and $\angle E + \angle P + \angle O + \angle H = 360^\circ$
 $\Rightarrow 360^\circ - 2\angle PSE + \angle O + \angle H = 360^\circ$

172. $x = 90^\circ, y = 60^\circ, z = 30^\circ$

173. False

Trap ABCD

in which $AD \parallel BC$

174. $\angle A = 120^\circ, \angle B = 105^\circ, \angle C = 75^\circ, \angle D = 60^\circ$

175. $l \parallel m$

$\angle DXY = \angle XYA$ (alt int. \angle s)

$\frac{\angle DXY}{2} = \frac{\angle XYA}{2}$ ($\div 2$)

$\angle 1 = \angle 2$ (XP and YQ are bisectors)

$\therefore XP \parallel QY$ (1)

Similarly $XQ \parallel PY$ (2)

From (1) and (2)

PXQY is a parallelogram

$\angle DXY + \angle XYB = 180^\circ$

$\frac{\angle DXY}{2} + \frac{\angle XYB}{2} = \frac{180^\circ}{2}$ (\div by 2)

$\angle 1 + \angle 3 = 90^\circ$ (4)

In $\triangle XYP$

$\angle 1 + \angle 3 + \angle P = 180^\circ$

$90^\circ + \angle P = 180^\circ$ (from 4)

$\angle P = 90^\circ$

From (3) and (5), PXQY is a rectangle

176. $\angle A = \angle C$ (opp. \angle s of a \parallel^{gm})

$\frac{\angle A}{2} = \frac{\angle C}{2}$ ($\div 2$)

$\angle 1 = \angle 2$

But $\angle 2 = \angle 3$ (all \angle s)

$\therefore \angle 1 = \angle 3$

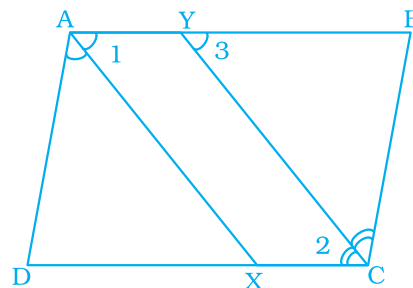
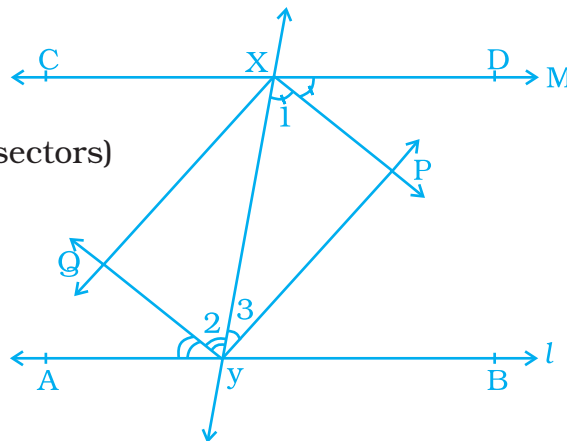
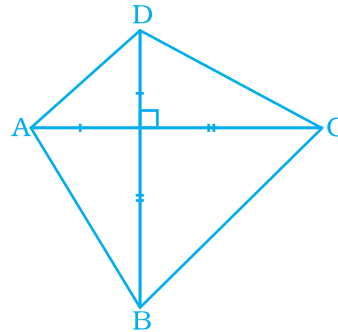

But they are a pair of corresponding \angle s

$$\therefore AX \parallel YC \quad (1)$$

$$AY \parallel XC \quad (2) \quad (AB \parallel DC)$$

From (1) and (2)

\square AXCY is a Parallelogram

177. Given: (i) ABCD is a \parallel^{gm}

$$(ii) \angle 1 = \angle 2$$

To Prove: (i) $\angle 3 = \angle 4$

(ii) ABCD is rhombus

Proof: (i) $\angle 1 = \angle 4$

$$\angle 2 = \angle 3 \quad (\text{alt } \angle\text{s})$$

$$\text{But } \angle 1 = \angle 2$$

$$\angle 3 = \angle 4$$

(ii) $\angle 1 = \angle 2$ (given alt.)

$$\angle 2 = \angle 3$$

$$\angle 1 = \angle 3$$

Hence $CD = DA$

\therefore ABCD is a rhombus

178. $135^\circ, 45^\circ, 135^\circ, 45^\circ$

179. $60^\circ, 120^\circ, 60^\circ, 120^\circ$

180. 45°

181. Given: ABCD is a \parallel^{gm} , bisector of $\angle A$, bisects BC in F i.e. $\angle 1 = \angle 2$, $CF = FB$

Const: Draw $FE \parallel BA$

Proof: ABFE is a \parallel^{gm} by const. ($FE \parallel BA$)

$$\angle 1 = \angle 6 \quad (\text{alt. } \angle)$$

But $\angle 1 = \angle 2$ (given)

$$\therefore \angle 2 = \angle 6$$

$$AB = FB \quad (1) \quad (\text{sides opp to equal } \angle\text{s})$$

\therefore ABFE is a rhombus

In $\triangle ABO$ and $\triangle BOF$

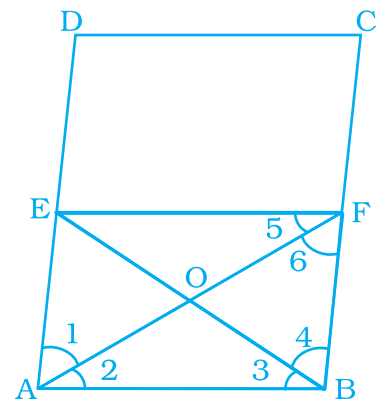
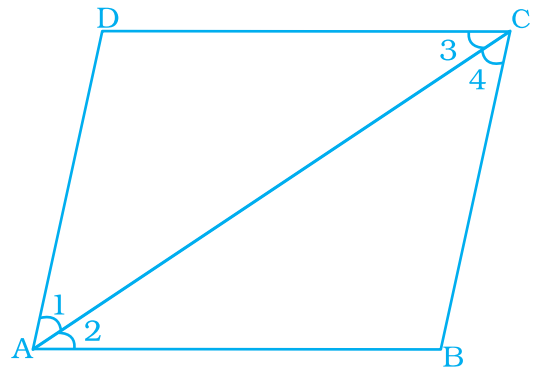

$AB = BF$ from (1)
 $BO = BO$ Common
 $AO = FO$ Diagonals bisect each other

$\triangle ABO \cong \triangle BOF$

$\angle 3 = \angle 4$

$BF = \frac{1}{2} BC$ (given)

$BF = \frac{1}{2} AD$ ($BC = AD$)

$AE = \frac{1}{2} AC$ ($BF = AE$)

$\therefore E$ is mid point of AD

182. 9°

183. 3, 3, 3. So, maximum number of acute angles is always 3.

184. (a) 116°

185. 30cm

186. $\angle A + \angle D = 180^\circ$

$105^\circ + \angle D = 180^\circ$

$\angle D = 75^\circ$

Steps of construction

1. Draw $AB = 4$ cm
2. Draw \overline{AX} such that $\angle BAX = 105^\circ$
3. Mark a point D on AX such that $AD = 3$ cm
4. Draw \overline{DY} such that $\angle ADY = 75^\circ$
5. Mark a point C such that $CD = 8$ cm
6. Join BC . $ABCD$ is the required trapezium.

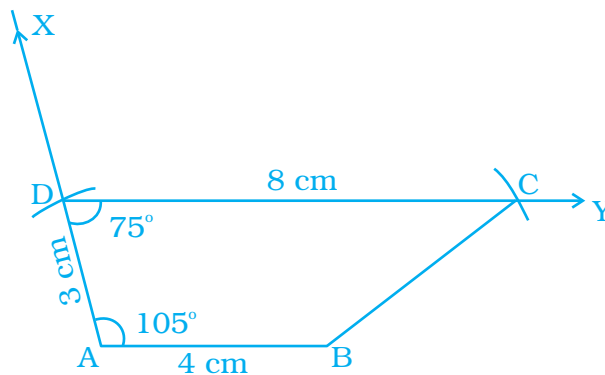

187. Opp sides of a \parallel gm are equal.

$AB = DC = 4$ cm

$BC = AD = 5$ cm

Steps of construction

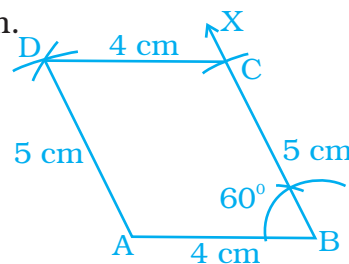

1. Draw $AB = 4$ cm
2. Draw ray BX such that $\angle ABX = 60^\circ$
3. Mark a point C such that $BC = 5$ cm
4. With C and A as centre, draw arcs intersecting at a point D respectively $ABCD$ is the required parallelogram.

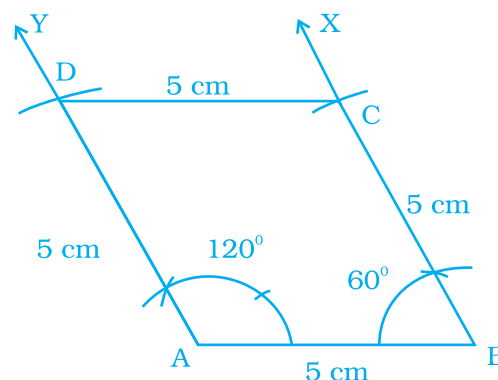

- 188.** $\angle B = 60^\circ$ (suppose)
 $\angle A + \angle B = 180^\circ$ (sum of co-interior angles)
 $\angle A + 60^\circ = 180^\circ$
 $\angle A = 120^\circ$
 $AB = BC = CD = DA = 5$ cm

Steps of construction

1. Draw $AB = 5$ cm
2. Draw ray AY such that $\angle BAY = 120^\circ$
3. Mark a point D such that $AD = 5$ cm
4. Draw ray BX such that $\angle ABX = 60^\circ$
5. Mark a point C such that $BC = 5$ cm
6. Joint C and D

$\therefore ABCD$ is the required rhombus

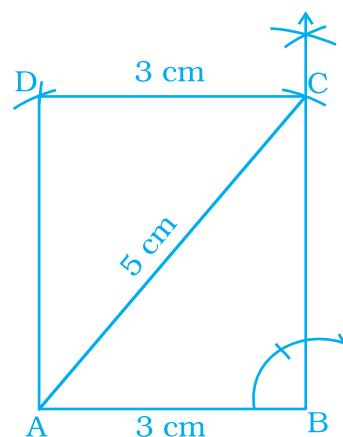

- 189.** Diagonals of a rectangle are equal.

$$AC = BD = 5 \text{ cm}$$

Steps of construction

1. Draw $AB = 3$ cm
2. Draw a ray BX such that $\angle ABX = 90^\circ$
3. Draw an arc such that $AC = 5$ cm
4. With B as centre, draw an arc of radius 5 cm. With C as centre draw another arc of radius 3 cm which intersect first arc at a point, suppose D .
5. Join CD and AD

ABCD is the required rectangle.

190.

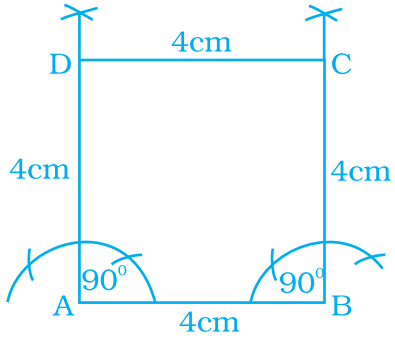

191.

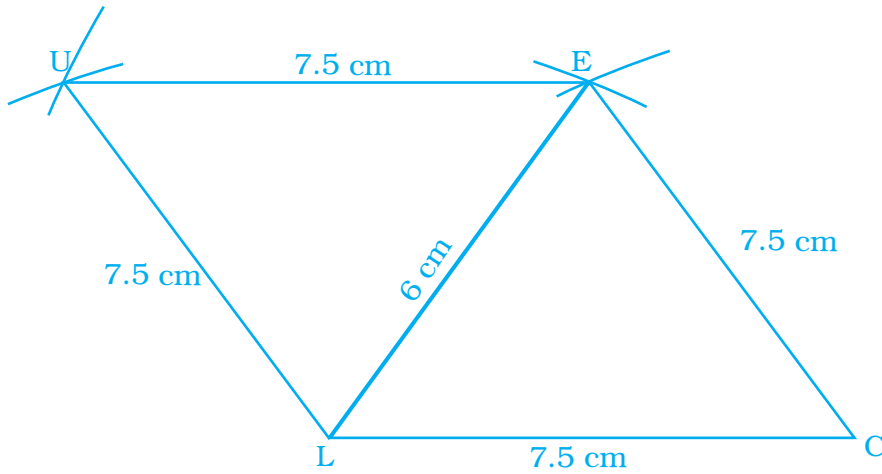

192.

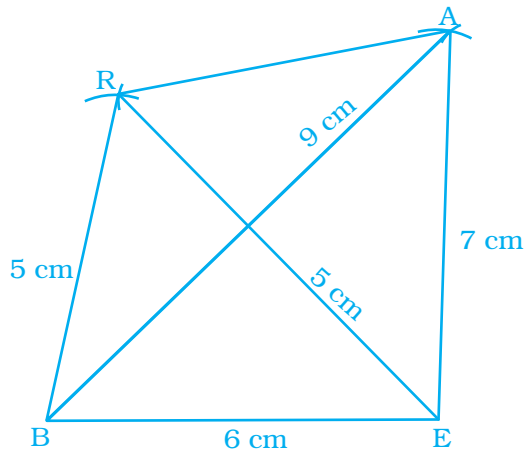

$RA = 5 \text{ cm}$

194. Cyclic quadrilateral

$$\angle B = \angle D = 90^\circ \quad (\text{Angle in a semicircle})$$

$$\angle A = \angle C = 90^\circ$$

$$\angle B + \angle D = 180^\circ$$

$$\angle A + \angle C = 180^\circ$$

opposite \angle s are supplementary.

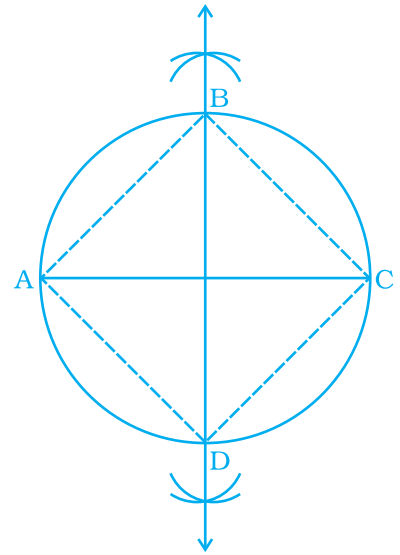

195.

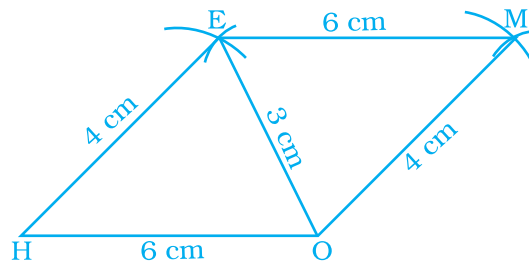

196. No,

In a Δ , sum of two sides always is greater than the third side.

$$AB + BC \not> AC$$

197. No,

$$\angle O + \angle R + \angle A = 120^\circ + 105^\circ + 135^\circ = 360^\circ$$

198.

Diagonals bisect at right angle

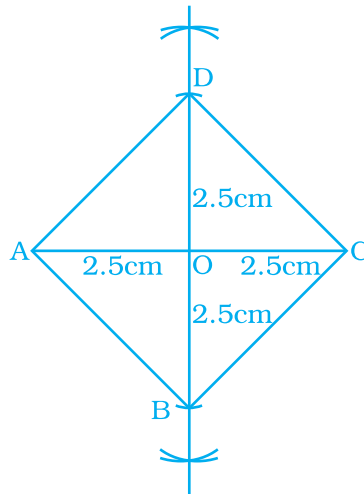

199.

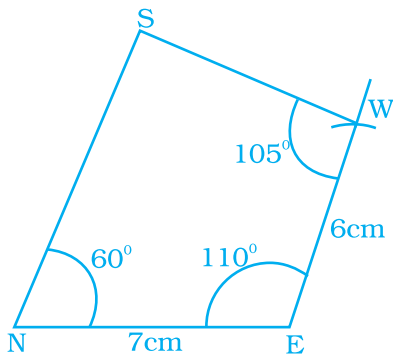

$$\begin{aligned} \text{Fourth angle} &= 360^\circ - (60^\circ + 110^\circ + 85^\circ) \\ &= 360^\circ - 255^\circ = 105^\circ \end{aligned}$$

200.

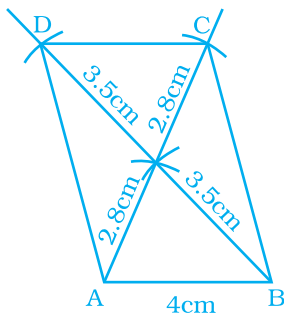

Other side = 5 cm

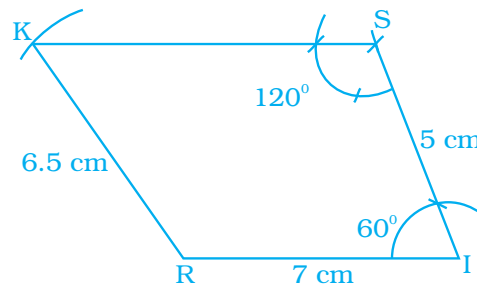

201. 72°

202. $\angle I + \angle S = 180^\circ$

$$60^\circ + \angle S = 180^\circ$$

$$\angle S = 120^\circ$$

203.

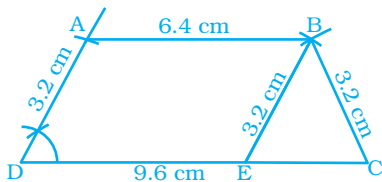

BEC is an equilateral triangle

$$\angle A = 120^\circ, \angle B = 60^\circ$$

Application, Games and Puzzles

Across

- 1. Trapezium 2. Polygon 3. Kite
- 4. Diagonal 5. Perpendicular 6. Opposite
- 7. Eight 8. Triangle 9. Regular
- 10. Nine

Down

- 11. Heptagon 12. Adjacent 13. Parallelogram
- 14. Equal 15. Pentagon 16. Bisect
- 17. Rhombus

The crossword puzzle grid is filled with the following words:

- 1. Trapezium
- 2. Polygon
- 3. Kite
- 4. Diagonal
- 5. Perpendicular
- 6. Opposite
- 7. Eight
- 8. Triangle
- 9. Regular
- 10. Nine
- 11. Heptagon
- 12. Adjacent
- 13. Parallelogram
- 14. Equal
- 15. Pentagon
- 16. Bisect
- 17. Rhombus

Unit 6

- 1.** (c) **2.** (a) **3.** (c) **4.** (a) **5.** (c) **6.** (d)
7. (a) **8.** (c) **9.** (a) **10.** (a) **11.** (a) **12.** (b)
13. (b) **14.** (b) **15.** (c) **16.** (d) **17.** (d) **18.** (b)
19. (b) **20.** (d) **21.** (c) **22.** cube **23.** cuboid **24.** 4
25. $n+1$ **26.** 30 **27.** Prism **28.** Cone **29.** Five **30.** Six
31. Same **32.** 4 **33.** 1:4400000 **34.** 7 **35.** 7
36. top **37.** eight **38.** 12 **39.** Five **40.** Congruent

41. a) Front view

Side view

Top view

- b) i) Side view
 ii) Top view
 iii) Front view
 c) i) Side view
 ii) top view
 iii) Front view
 d) i) Side
 ii) Front
 iii) Top

- 42.** False **43.** False **44.** True **45.** False **46.** False **47.** False
48. False **49.** False **50.** True **51.** False **52.** False **53.** True
54. False **55.** True **56.** True **57.** False **58.** True **59.** True
60. True **61.** True
62. (a) 6, 8, 12, 14, 14,
 (b) 4, 4, 6, 8, 8
 (c) 5, 5, 8, 10, 10
 (d) 5, 5, 8, 10, 10
 (e) 6, 6, 10, 12, 12
 (f) 7, 7, 12, 14, 14
 (g) 5, 6, 9, 11, 11
 (h) 6, 8, 12, 14, 14

- (i) 6, 8, 12, 14, 14
- (j) 7, 10, 15, 17, 17
- (k) 10, 16, 24, 26, 26
- (l) 9, 14, 21, 23, 23

- 63.** a) 4
 b) 6
 c) 9
 d) 8

64.

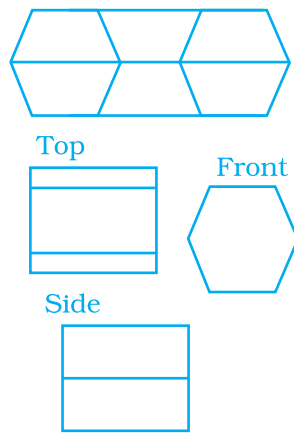

- 65.** (a) 1 (b) none (c) none
 (d) 9 (e) 4 (f) 12
- 66.** (a) 1 (b) 2 (c) none
 (d) 16 (e) 18 (f) 9
- 67.** (c), (f), (m) and (k) are not polyhedrons
- 68.** (a) 10 (b) 10 (c) 10 (d) 9
 (e) 11 (f) 9 (g) 11 (h) 110
 (i) 113 (j) 66 (k) 15 (l) 14

- 69.** Front view Side view Top view
- (a)
-

(b)

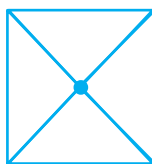
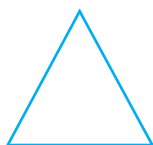
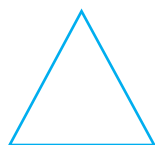

(c)

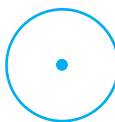
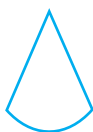

(d)

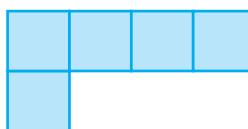
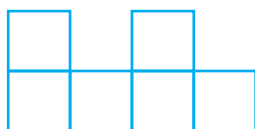

(e)

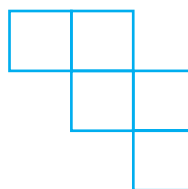

(f)

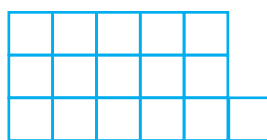
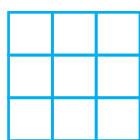
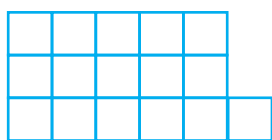

(g)

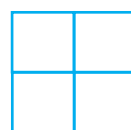
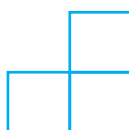
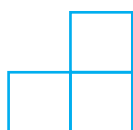

(h)

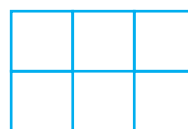
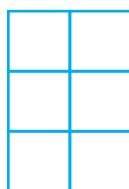
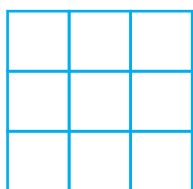

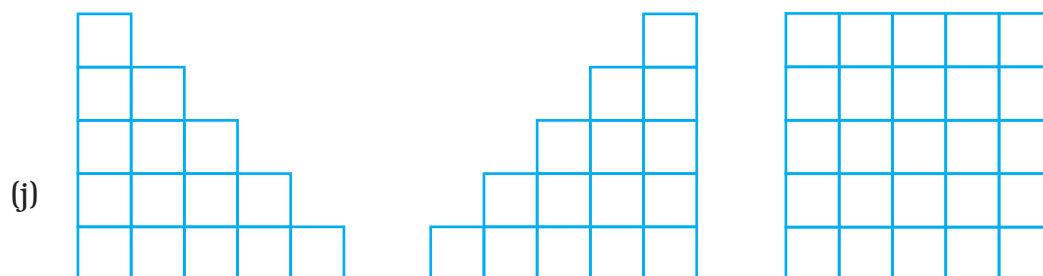
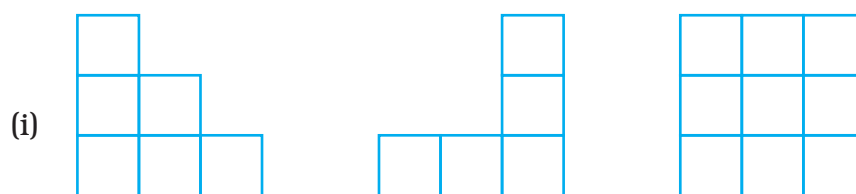

70. $x = 15$

$y = 8$

$z = 9$

$p = 8$

$q = 8$

$r = 17$

71. Yes, draw an octagonal pyramid.

72. No.

73. 22

74. (a) 14 (b) 10 (c) 16

75. 30

76. 22

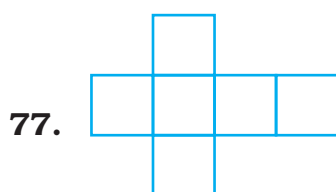

78.



79.

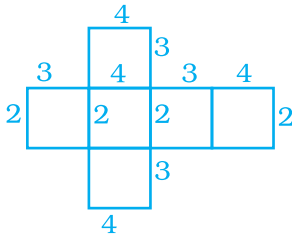

80. i) b
 ii) d
 iii) a
 iv) c

81. 1. Prism, Pyramid
 2. Pyramid
 3. Cone, Cylinder
 4. Prism, Pyramid
 5. Cylinder, Prism
 6. Pyramid
 7. Cone

82.

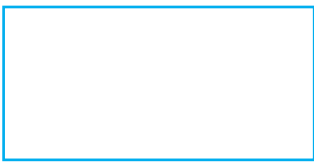

83.

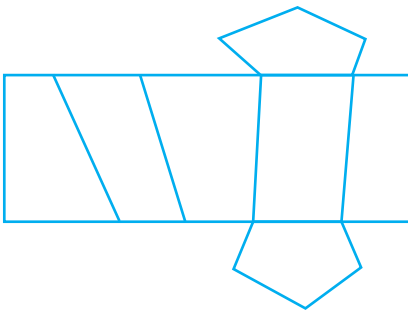

84. 7

85.

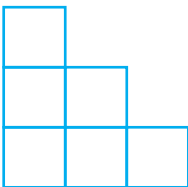

86. $F = n+1$
 $V = n+1$
 $E = 2n$

87.

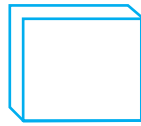

It is a cuboid. Yes.

- 88.** a) Cylindrical mounted by hemi sphere.
b) Hexagonal prism mounted by a cone.

89. Cuboid

- 91.** a) Cube
b) Cuboid
c) Cylinder
d) Cone
e) Square Pyramid
f) Triangular prism

- 92.** a) 2.1 acre
b) Govt Model School I and II
c) Park A
d) B block
e) 6

- 93.** a) AIIMS and Safdarjang Hospital
b) Sirifort Auditorium, Bhel, Asiad Tower
c) August Kranti Marg

- 94.** a) Flower Road
Khel Marg, Mall Road
and Sneha Marg,
b) Stadium, Sector 27
B Town, B Town India
c) Sneha Marg
d) H.N.I, Nr. Bank
Sector 19, B Town India
e) Sector 27
f) Sector not mentioned
g) 3.

96. 1:2 97. 5:1 98. 25 km

99. 1) 60 km
 2) 20 km
 3) 35 km

100. 10 mm 101. a) 1 cm = 4 m b) 1 inch = 9 feet
 102. 12 cm

Activity, Crossword Puzzle

Across

1. Prism 2. Pentagonal
 5. Cuboid 7. Tetrahedron
 8. Convex

Down

2. Pyramid 3. Diagonal
 4. Sphere 6. Cone
 7. Two 9. Vertex

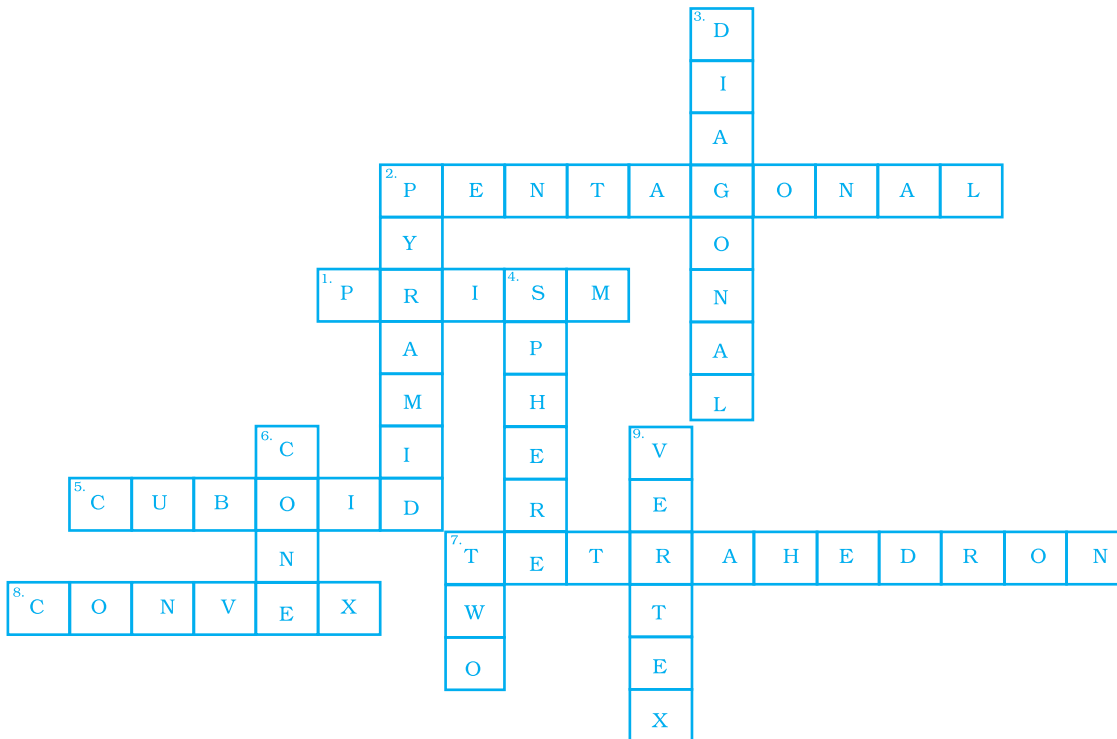

Unit 7

- 1.** (b) **2.** (b) **3.** (b) **4.** (d) **5.** (d) **6.** (b)
7. (d) **8.** (a) **9.** (a) **10.** (b) **11.** (a) **12.** (b)
13. (d) **14.** (b) **15.** (c) **16.** (c) **17.** (b) **18.** (c)
19. (a) **20.** (b) **21.** (a) **22.** (c) **23.** (c) **24.** (a)
25. (c) **26.** (c) **27.** (b) **28.** (b) **29.** (d) **30.** (b)
31. (d) **32.** (c) **33.** (a) **34.** positive **35.** negative
36. $ab + ac$ **37.** $(a - b)^2$ **38.** $(a + b)(a - b)$
39. $2ab - 2b^2$ **40.** $a^2 + b^2$ **41.** ab **42.** polynomial
43. x **44.** $2m(9 + 5p)$ **45.** $(2y - 3)(2y - 3)$ **46.** $2x^2z$
47. $24xyz$ **48.** $(67 + 37)$ **49.** 205
50. $12x^2y^2$ **51.** $8x^3$ **52.** -37 **53.** 2
54. $16(a^2 + b^2)$ **55.** distributive law **56.** $3y$ **57.** $x + 1$
58. $x + 2y$ **59.** False **60.** False **61.** True **62.** False
63. True **64.** True **65.** False **66.** False **67.** False **68.** True
69. False **70.** False **71.** False **72.** True **73.** False **74.** False
75. True **76.** True **77.** False **78.** True **79.** False **80.** True
81. i) $10a^2bc - abc^2$ ii) $10ax - 2by + 2cz$
iii) $4xy^2z^2 - 6x^2y^2z - 3x^2yz^2$ iv) $3x^2 + 2xy + 11y^2 + 4$
v) $-p^4 - 10p^3 - 2p^2 - 6p - 5$ vi) $3a^2 - ab + 3ac + 2bc - 2b^2$
vii) $6ab + 21ac + 6bc$
82. i) $-12a^2b^2c^2$ ii) $-9x^2 + 10xy + 3y^2$
iii) $2ab^2c^2 - 14a^2b^2c + 7a^2bc^2$ iv) $-7t^4 + 12t^3 - 6t^2 + 4t + 5$
v) $3ab - 7bc + 5ac + 10abc$ vi) $-33p^2 - 77pq$
vii) $-3ap - 3pr - 3pq - 3px$

83. i) $91p^4q^4r^4$ ii) $51x^3y^3z^3$ iii) $255xy^3z^2$ iv) $-715a^4b^3c^3$

v) $-15x^2y^2 + 3x^3y^2$ vi) ab^2c^2

vii) $7p^2qr - 7pq^2r + 7pqr^2$ viii) $x^3y^3z^2 - x^2y^3z^3 + x^3y^2z^3$

ix) $pq - 7p + 6q - 42$ x) 0 xi) a^{12} xii) $-91S^2t^3$

xiii) $21ab^{10}$ xiv) $-\frac{25}{3}r^4s^3$ xv) $a^4 - b^4$ xvi) $a^2b^2 + 2abc + c^2$

xvii) $p^2q^2 - 4pqr + 4r^2$ xviii) $\frac{1}{2}x^2 + \frac{17}{72}xy - 2y^2$

xix) $3p^4 - \frac{19}{6}p^2q^2 - 2q^4$ xx) $2x^3 - 3x^2 - 23x + 42$

xxi) $6x^4 - 4x^3 - 23x^2 + 44x - 24$ xxii) $2x^2 + 7x - 13y - 2y^2 - 15$

84. i) $18x^2 + 8y^2$ ii) $24xy$

iii) $\frac{49}{81}a^2 + ab + \frac{81}{49}b^2$ iv) $\frac{9}{16}x^2 + \frac{16}{9}y^2$

v) $7.2pq$ vi) $2.5m^2 + 4.5q^2$ vii) x^4

viii) $a^2b^2 + c^2$ ix) $-2b^3$ x) $b^3 - 49b + 7b^2$

xi) $40.5a^2 + 27ab + 4.5b^2$ xii) $p^2q^2 + 2pq^2r + q^2r^2$

xiii) $s^4t^2 - 2s^2t^2q^2 + t^2q^4$

85. i) $x^2y^2 + 2xy^2z + y^2z^2$ ii) $x^4y^2 - 2x^3y^3 + x^2y^4$

iii) $\frac{16}{25}a^2 + 2ab + \frac{25}{16}b^2$ iv) $\frac{4}{9}x^2 - 2xy + \frac{9}{4}y^2$

v) $\frac{16}{25}p^2 + \frac{8}{3}pq + \frac{25}{9}q^2$ vi) $x^2 + 10x + 21$

vii) $4x^2 + 4x - 63$ viii) $\frac{16}{25}x^2 + \frac{4xy}{5} + \frac{3y^2}{16}$

ix) $\frac{4}{9}x^2 - \frac{4}{9}a^2$ x) $4x^2 - 20xy + 25y^2$

xi) $\frac{4}{9}a^2 - \frac{b^2}{9}$

xii) $x^4 - y^4$

xiii) $a^4 + 2a^2b^2 + b^4$

xiv) $49x^2 + 70x + 25$

xv) $1296a^4 + 2401b^4 - 3528a^2b^2$

xvi) $0.81p^2 - 0.9pq + 0.25q^2$

86. i) 2704

ii) 2401

iii) 10609

iv) 9604

v) 1010025

vi) 990025

vii) 2491

viii) 2756

ix) 9975

x) 10088

xi) 10403

xii) 10094

xiii) 98.01

xiv) 99.96

xv) 103.02

xvi) 1050

xvii) 3860

xviii) 94

xix) 12800

xx) 89000

xxi) 458000

87. i) $18a$

ii) $3xy$

iii) y

iv) lmn

v) $7pqr$

vi) ry

vii) $3xyz$

viii) $3prs$

ix) $13xy$

x) 1

88. i) $6b(a + 2c)$

ii) $-y(x + a)$

iii) $x(ax^2 - bx + c)$

iv) $lmn(lm + mn - ln)$

v) $3r(pq - 2p^2q^2r - 5r)$

vi) $xy(x^2y + xy^2 - y^3 + 1)$

vii) $2xy(2y - 5x + 8xy + 1)$

viii) $a(2a^2 - 3ab + 5b^2 - b)$

ix) $3pqrs(21pqr - 3qrs + 5prs - 20pqs)$

x) $xyz(24xz^2 - 6y^2z + 15xy - 5)$

xi) $(a + 1)(a^2 + 1)$

xii) $(x + y)(l + m)$

xiii) $x(a^2 - x^2)(a + x)$

xiv) $(x + 2y)(2x - 1)$

xv) $(y - 4z)(y - 2x)$

xvi) $x(ax + by)(y - z)$

xvii) $(a^2 + a + bc)(b + c)$

xviii) $(2a + 3b)(x + y)^2$

89. (i) $(x + 3)(x + 3)$

(ii) $(x + 6)(x + 6)$

(iii) $(x + 7)(x + 7)$

(iv) $(x + 1)(x + 1)$

(vi) $(ax + 1)(ax + 1)$

(viii) $(ax + by)(ax + by)$

(ix) $(2x + 3)(2x + 3)$

(xi) $(3x + 4)(3x + 4)$

(xiii) $2x(x + 6)(x + 6)$

(xv) $x^2(2x + 3)(2x + 3)$

(xvii) $\left(3x + \frac{y}{3}\right)\left(3x + \frac{y}{3}\right)$

90. (i) $(x - 4)(x - 4)$

(iii) $(x - 7)(y - 7)$

(iv) $(p - 1)(p - 1)$

(vi) $(py - 1)(py - 1)$

(viii) $(3x - 2)(3x - 2)$

(x) $\left(\frac{x}{2} - 2\right)\left(\frac{x}{2} - 2\right)$

(xii) $\left(3y - \frac{2x}{3}\right)^2$

91. (i) $(x + 13)(x + 2)$

(iii) $(x + 5)(x + 13)$

(v) $(y + 7)(y - 3)$

(vii) $(9 + x)(2 + x)$

(ix) $(x - 12)(x - 5)$

(xi) $(y + 4)(y + 3)$

(xiii) $(a - 20)(a + 4)$

(v) $(2x + 1)(2x + 1)$

(vii) $(ax + b)(ax + b)$

(x) $(4x + 5)(4x + 5)$

(xii) $(3y + 5)(3y + 5)$

(xiv) $x(ax + b)(ax + b)$

(xvi) $\left(\frac{x}{2} + 2\right)\left(\frac{x}{2} + 2\right)$

(ii) $(x - 5)(x - 5)$

(v) $(2a - b)(2a - b)$

(vii) $(ay - b)(ay - b)$

(ix) $(2y - 3)(2y - 3)$

(xi) $y(ay - b)(ay - b)$

(ii) $(x + 5)(x + 4)$

(iv) $(p + 1)(p + 13)$

(vi) $(y - 5)(y + 3)$

(viii) $(x - 7)(x - 3)$

(x) $(x + 11)(x - 7)$

(xii) $(p - 15)(p + 2)$

- 92.** (i) $(x - 3)(x + 3)$ ii) $(2x - 5y)(2x + 5y)$
 iii) $(2x - 7y)(2x + 7y)$ iv) $3a^2b(b - 3a)(b + 3a)$
 v) $7a(2y - 5x)(y^2 + 5x)$ vi) $(3x - 1)(3x + 1)$
 vii) $25a(x - 1)(x + 1)$ viii) $\left(\frac{x}{3} - \frac{y}{5}\right)\left(\frac{x}{3} + \frac{y}{5}\right)$
 ix) $2\left(\frac{p}{5} - 4q\right)\left(\frac{p}{5} + 4q\right)$ x) $(7x - 6y)(7x + 6y)$
 xi) $y\left(y - \frac{1}{3}\right)\left(y + \frac{1}{3}\right)$ xii) $\left(\frac{x}{5} - 25\right)\left(\frac{x}{5} + 25\right)$
 xiii) $\frac{1}{2}\left(\frac{x}{2} - \frac{y}{3}\right)\left(\frac{x}{2} + \frac{y}{3}\right)$ xiv) $\left(\frac{2}{3}x - \frac{3}{4}y\right)\left(\frac{2}{3}x + \frac{3}{4}y\right)$
 xv) $xy\left(\frac{x}{3} - \frac{y}{4}\right)\left(\frac{x}{3} + \frac{y}{4}\right)$ xvi) $11xy(11x - y)(11x + y)$
 xvii) $b^2\left(\frac{1}{6}a - \frac{4}{7}b\right)\left(\frac{1}{6}a + \frac{4}{7}b\right)$
 xviii) $2ab(2a^2 - 2ab + b^2)$ xix) $(x - 1)(x + 1)(x^2 + 1)$
 xx) $(y - 5)(y + 5)(y^2 + 25)$ xxii) $p(p - 2)(p + 2)(p^2 + 4)$
 xxiii) $(2x - 3)(2x + 3)(4x^2 + 9)$ xxiv) $(x - y)(x + y)(x^2 + y^2)$
 xxv) $(y - 3)(y + 3)(y^2 + 9)$
 xxvi) $(2x - 5y)(2x + 5y)(4x^2 + 25y^2)$
 xxvii) $(a - 2b + c)(a - c)$ xxviii) $8xy(x^2 + y^2)$
 xxviii) $(x - y)(x + y)(x^2 + y^2 + 1)$ xxix) $2a(2a - 1)(2a + 1)$
 xxx) $\left(x - \frac{y}{10}\right)\left(x + \frac{y}{10}\right)$ xxxi) $(3x - 3y - 3)(3x + 3y + 3)$
- 93.** (i) $x - 2$ and $x - 4$ (ii) $x - 1$ and $x - 2$ (iii) $x - 2$ and $x - 5$

(iv) $x + 20$ and $x - 1$

(v) $x + 5$ and $x + 4$

94. (i) $3x^2y$ (ii) $4\frac{xz^3}{y}$ (iii) $-17bc$

(iv) $\frac{11p^3q^3r^3}{xy^2z^3}$

95. (i) $r - 2pqr^2$ (ii) $\frac{-a}{d}x^2 + \frac{b}{d}x - \frac{c}{d}$ (iii) $x^2y^2 + xy^2 - y^3 + 1$

(iv) $\frac{qr}{z} - \frac{pr}{x} + r$

96. (i) $x - 9$ (ii) $x + 12$ (iii) $2x$
(iv) $3x - 2$ (v) $3(x + 4)$ (vi) $x - 2$

(vii) $x^2 + 25$

97. $2x + 3y$ 98. $3x + 4y$ 99. $x + 8$

100. $y - 4$ 101. $x + 3$ 102. $\frac{1}{2}n(n+1)$

103. $(x^2 + 25)(x - 5)$ 104. $7xy(x^4 + y^4)$

105. Rs $x^2 + 8x + 16$; Rs 196

106. $4x^2 - 9$ sq. units; 391 sq. units 107. $44(ab - b(-2ac))$

108. 100 109. 200 110. 225

111. 72 112. 12

114. (i) 62 (ii) 143 (iii) 12 (iv) 8

115. $3a^2 + ab + 7ac + 2b^2 - 6bc - 4c^2$

116. $-b^3 + 2b^2 + 7b - 8$; 16 117. 51

118. $\left(x + \frac{1}{x}\right)\left(x + \frac{1}{x} - 3\right)$ 119. $(p^2 + q^2 - pq)(p^2 + q^2 + pq)$

120. (i) 8 (ii) 300 121. $x(x^2 - x + 1)$

122. Side = 25 units; $x = 5$ 124. $10x(2x + 1)$ sq. units

125. (i) - (b) (ii) - (c) (iii) - (a)

Unit 8

- 1.** (c) **2.** (a) **3.** (b) **4.** (a) **5.** (c) **6.** (c)
7. (a) **8.** (c) **9.** (c) **10.** (a) **11.** (a) **12.** (b)
13. (a) **14.** (b) **15.** (c) **16.** (b) **17.** (d) **18.** (d)
19. (b) **20.** (d) **21.** (c) **22.** (b) **23.** (a) **24.** (d)
25. (a) **26.** (d) **27.** (c) **28.** (a) **29.** (c) **30.** (a)
31. (b) **32.** (c) **33.** (b) **34.** 10^{-10} **35.** a^{-7} **36.** 1
37. 1 **38.** $\frac{1}{2^6}$ **39.** 2^{-6} **40.** Negative
41. Positive **42.** 10^{-5} **43.** $\frac{2}{13}^{-36}$ **44.** $\frac{36}{22}$
45. 1 **46.** 1.0×10^{-8} **47.** 1.234×10^7
48. 3410000 **49.** 2394610 **50.** 6^{-2} **51.** 3^4 or 81
52. 3^{11} **53.** 0.0000003 **54.** equal **55.** 3.25×10^{10}
56. 8×10^{-9} **57.** 0.000000000^{23} **58.** 8^4
59. 2^{10} **60.** 12^{-2} or $\frac{1}{144}$ **61.** 6 **62.** 0
63. $\frac{1}{3^{-5}}$ **64.** 1 **65.** 49 **66.** False
67. True **68.** True **69.** False **70.** True
71. Flase **72.** Flase **73.** False **74.** False
75. False **76.** False **77.** False **78.** True
79. True **80.** False **81.** False **82.** True
83. True **84.** True **85.** True **86.** True
87. False **88.** False **89.** True **90.** True
91. (i) 100^{10} (ii) 2^5 (iii) $\frac{1}{2}^{-1}$

- 92.** $\frac{1}{3^9}$ **93.** 2^{-8} **94.** $\frac{3}{4}^3$ and $\frac{3}{4}^3$
- 95.** $\frac{4}{9}^2$ and $\frac{4}{9}^2$ **96.** (a) $\frac{2}{3}^6$ (b) 2^{-10}
- 97.** -128
- 98.** (i) 29 (ii) $\frac{3^8}{2^7}$ (iii) $\frac{7^5}{10} z^2$ (iv) 2^{-10} or $\frac{1}{1024}$
- 99.** (i) $x = -2$ (ii) $x = -1$ (iii) $x = 0$
- 100.** 2.93×10^{-4} **101.** $(100)^9$ **102.** 1 **103.** 1
- 104.** $\frac{49}{90}$ **105.** $x = 2$ **106.** 3.9×10^8
- 107.** 5.678×10^{-6} **108.** 1.312×10^6
- 109.** 6.0×10^9 **110.** 1.5×10^7 **111.** 5.913×10^9 km
- 112.** 1.0×10^{-8} g **113.** 3.72×10^6 kg **114.** 1.25×10^{12}
- 115.** (a) 1.673×10^{-24} gm (b) 2.2×10^{-8} cm
 (c) 3.34×10^{-21} tons (d) 10^{12}
 (e) 5.6×10^4 (f) 5.0×10^5
 (g) 6.3072×10^7 sec (h) 5.0×10^8 cm²
- 116.** $x = -1$ **117.** $\frac{2^7}{3^9}$ **118.** $n = 1$ **119.** $n = 9$
- 120.** $625x^3$ **121.** 400 **122.** $n = 6$ **123.** 16 kg
- 124.** (a) 2^{24} (b) 2^{48} **125.** B **126.** 2^8
- 127.** (a)

Number of Hops	Distance Covered	Distance Left	Distance Covered
1.	$\frac{1}{2}$	$\frac{1}{2}$	$1 - \frac{1}{2}$
2	$\frac{1}{2} \frac{1}{2} \frac{1}{2}$	$\frac{1}{4}$	$1 - \frac{1}{4}$
3	$\frac{1}{2} \frac{1}{4} \frac{3}{4}$	$\frac{1}{8}$	$1 - \frac{1}{8}$
4	$\frac{1}{2} \frac{1}{8} \frac{7}{8}$	$\frac{1}{16}$	$1 - \frac{1}{16}$
5.	$\frac{1}{2} \frac{1}{16} \frac{15}{16}$	$\frac{1}{32}$	$1 - \frac{1}{32}$
6.	$\frac{1}{2} \frac{1}{32} \frac{31}{32}$	$\frac{1}{64}$	$1 - \frac{1}{64}$
7.	$\frac{1}{2} \frac{1}{64} \frac{63}{64}$	$\frac{1}{128}$	$1 - \frac{1}{128}$
8.	$\frac{1}{2} \frac{1}{128} \frac{127}{128}$	$\frac{1}{256}$	$1 - \frac{1}{256}$
9.	$\frac{1}{2} \frac{1}{256} \frac{255}{256}$	$\frac{1}{512}$	$1 - \frac{1}{512}$
10.	$\frac{1}{2} \frac{1}{512} \frac{511}{512}$	$\frac{1}{1024}$	$1 - \frac{1}{1024}$

127. (b) $1 - \frac{1}{2}^n$

(c) No, because for reaching 1, $\frac{1}{2}^n$ has to be zero for some finite n which is not possible.

128. (a)

x	1^x	2^x	3^x	4^x	5^x	6^x	7^x	8^x	9^x	10^x
1	1	2	3	4	5	6	7	8	9	10
2	1	4	9	16	25	36	49	64	81	100
3	1	8	27	64	125	216	343	512	729	1000
4	1	16	81	256	625	1296	2401	4096	6561	10000
5	1	32	243	1024	3125	7776	16807	32768	59049	100000
6	1	64	729	4096	15625	46656	117649	262144	531441	1000000
7	1	128	2187	16384	78125	279936	823543	2097152	4782969	10000000
8	1	256	6561	65536	390625	1679616	5764801	16777216	43046721	100000000
One digit of the Power	1	2,4,8,6	3,9,7,1	4,6	5	6	7,9,3,1	8,4,2,6	9,1	0

(b) (1) 6 (2) 1 (3) 3 (4) 5 (5) 0

(c) (1) 1 (2) 4 (3) 7 (4) 1

129. (a) Sun - 1.99×10^{30} Mercury - 3.3×10^{23} Venus - 4.87×10^{24} Earth - 5.97×10^{24} Mars - 6.42×10^{29} Jupiter - 1.9×10^{27} Saturn - 5.68×10^{26} Uranus - 8.68×10^{25} Neptune - 1.02×10^{26} Pluto - 1.27×10^{22} Moon - 7.35×10^{22}

(b) Pluto < Moon < Mercury < Venus < Earth < Uranus < Neptune < Saturn < Jupiter < Mars.

(c) Venus

130. (a) Sun - 1.496×10^8 Jupiter - 7.783×10^8 Mars - 2.279×10^8 Mercury - 5.79×10^7 Neptune - 4.497×10^9 Pluto - 5.9×10^9 Saturn - 1.427×10^9 Uranus - 2.87×10^9 Venus - 1.082×10^8

(b) Mercury, Venus, Earth, Mars, Jupiter, Saturn, Uranus, Neptune, Pluto.

131. (a) Lead (b) Titanium

(c) Hydrogen < Lithium < Titanium < Silver < Lead

132. 2.8968192×10^{12} m 133. 2.543×10^{-2} m

- 134.** 0.000000767 **135.** $9.1093826 \times 10^{-28}$ g
- 136.** Six thousand one hundred million.
- 137.** (a) Generation Ancestor
- | | |
|----|----------|
| 1 | 2 |
| 2 | 2^2 |
| 12 | 2^{12} |
- (b) 2^n
- 138.** 1610 billion in a week or 1.61×10^{12}
83950 billion in an year or 8.395×10^{14}
- 139.** 37.5 g **140.** (a) $\frac{1}{3^7}$ (b) 5 half lines
- 141.** 1.3×10^{-15} m **142.** 5.0×10^{-2} m
- 144.** $\textcircled{144} \times 2^{-3}$ $\textcircled{18} \times 12^{-1}$ $\textcircled{\frac{3}{2}} \times 3^{-2}$ $\textcircled{\frac{1}{6}}$
- 145.** 1.15×10^{-5} days
- 146.** (a) Bajra, Jawar, Rice
(b) Bajra 1.3×10^3
Jawar 1.26×10^6
Rice 3.6×10^3
Wheat 7.0×10^5
(c) 3.0×10^3 hectares
- 147.** 40 cm
- 148.** (a) ($\times 2^2$) and yes ($\times 5^2$) hooked together
(b) ($\times 4$) machine
- 149.** 64 cm
- 150.** (a) Two times
Total stretch is 10,000
(b) Five times
Total stretch 16,807
(c) Seven times
Total Stretch is 78,125

151. $(\times 4^3)$, $(\times 8^2)$, $(\times 2^6)$ machines **152.** It will remain same.

153. (a) They do not change its length. (b) 1 **154.** 3 cm

155. (i) 1 cm (ii) $\frac{1}{8}$ cm or 0.125 cm **156.** $\frac{1}{9}$ cm **157.** 5

158. (a) $(\times 2)$ (b) $(\times 2^2)$ (c) $(\times \frac{1}{5})$

159. (a) 2^9 (b) 100^{12} (c) 7^{61}

(d) 3^{2y} (e) 2^3 (f) $\frac{1}{6}^2$

160. (a) Yes, $(\times 7^5)$ (b) No (c) No

(d) Yes, $(\times (0.5)^5)$ (e) Yes, $(\times 12^5)$

161. $(\times 6^3)$ **162.** $5^2 \times 5^2$

163. (a) $(\times 2^0)$ (b) $(\times 5^{-1})$ (c) 5 cm (change in question)

(d) 3 cm

164. (a) $2^2 \times 5^2$ (b) $3^2 \times 11^1$

(c) $(\times 37)$ (d) 101×111

165. $\times 3^4$, $\times 9^2$

166. $x \frac{1}{2}^3$

167. $a \times 25$, $a \times 125$, $a \times 625$

168. $\times 125$

169.

	Machine		
Input length	x^2	x^{10}	x^5
0.5	1	5	2.5
3	6	30	15
7	14	70	35

170. Give them a 8×8 grid

Now find sum of each row, e.g. 1st row

$$= 2^0 + 2^1 + 2^2 + 2^3 + 2^4 + 2^5 + 2^6 + 2^7$$

$$= 255$$

2nd row

$$= 2^8 + 2^9 + 2^{10} + 2^{11} + 2^{12} + 2^{13} + 2^{14} + 2^{15}$$

$$= 2^8 (2^0 + 2^1 + 2^2 + 2^3 + 2^5 + 2^6 + 2^7)$$

$$= 2^8 \times 255$$

$$= 256 \times 255$$

$$= 65280$$

3rd row

$$= 2^{16} \times 255$$

$$= 16711680$$

$$2^8 = 256$$

$$2^{16} = 2^8 \times 2^8$$

$$= 256 \times 256$$

and so on

171. Diameter of sun is 100 times the diameter of earth)

172. 26.32×10^{29} kg **173.** 1492.16×10^8 m **174.** 2.7×10^8 sec

175. 3 **176.** $\frac{64}{27}$

177. (1) $x = -2$ (2) $x = -7$ (3) $x = 6$

(4) $x = 7$ (5) $x = -1$ (6) $x = 4$

178. (1) $\frac{3}{2}$ (2) $\frac{1}{2}$ (3) $\frac{1}{2}$ (4) 2

179. (1) $\frac{6}{11}^4$ (2) $\frac{5}{7}^3$ (3) $\frac{20}{63}^2$ (4) $\frac{5}{10}^4$ or $\frac{1}{2}^4$

180. (1) $\frac{8}{15}$ (2) 0 (3) $\frac{28}{169}$ (4) 0

(5) $3^7 \times t^2$ (6) $(3t)^6$

Activities

Activity 1

Number of Cuts	Number of Ballots
1	2 (= 2^1)
2	4 (= 2^2)
3	8 (= 2^3)
4	16 (= 2^4)

- (a) 2^n (b) 2^{40} (c) 9 cuts
(d)

Number of Cuts	Area (cm ²)
0	324
1	162
2	81
3	40.5
4	20.25
5	10.125
6	5.0625
7	2.53125
8	1.265625
9	0.6328125
10	0.3164062

Formula – $A \times 2^{-n}$ (changes made in question)

- (e) 8192 cm²

Activity 2

(a)

Number of Steps	Number of Ballots
1	3
2	3^2
3	3^3
4	3^4
5	3^5

- (b) 3^{15} , 3^n (c) At least 11 steps

Unit 9

- 1.** (a) **2.** (b) **3.** (b) **4.** (a) **5.** (c) **6.** (a)
7. (c) **8.** (b) **9.** (d) **10.** (b) **11.** (a) **12.** (c)
13. (c) **14.** (b) **15.** (a) **16.** (c) **17.** (c) **18.** (b)
19. (b) **20.** (c) 20.8% **21.** Discount **22.** 200 **23.** 1 : 10
24. Discount = M.P. – S.P. **25.** Discount = Discount % of M.P.
26. Sales tax **27.** $A = P \left(1 + \frac{R}{100}\right)^n$ **28.** Sales tax = tax% of Bill amount
29. Conversion period **30.** Overhead expenses
31. Marked Price **32.** $A = P \left(1 + \frac{r}{200}\right)^2$
33. equal, denominator **34.** Rs 1,000
35. A = Rs 9331.20, CI = 1331.20 **36.** Rs 27,000
37. 10%, $1\frac{1}{2}$ years
38. $x + \frac{40}{100}x = 1,12,000$ (Let C.P. be x)

$$\frac{140x}{100} = 1,12,000$$

$$x = \frac{1,12,000 \times 100}{140} = 8000$$
39. $\frac{20}{3}\%$ or $6\frac{2}{3}\%$ **40.** 100% **41.** Rs 364 **42.** Rs 10,000
43. 400% **44.** 300% **45.** Rs 199.50 **46.** True
47. False **48.** False **49.** True **50.** False
51. False **52.** False **53.** False **54.** True

- 55.** False **56.** True **57.** True **58.** False
59. True **60.** False **61.** False **62.** False
63. True **64.** True **65.** False **66.** 840
67. 29.67 kg, 23.73 kg, 10.79 kg or 10.8 kg (approx.)
68. (a) Rs 5177.50 (b) Rs 1280.50 **69.** (a) Rs 500 (b) Rs 10,000
70. (a) 10% (b) 3% **71.** Rs 380 **72.** Increase 5.76 **73.** $\frac{50}{3}\%$
74. 3703 **75.** 3019.14
76. (a) 40% (b) $\frac{32}{3}\% = 10\frac{2}{3}\%$ (c) 20%
77. 55.84%, 2.23% **78.** (a) Rs 664.95 (b) Rs 1243.26
(c) Rs 2305.38 (d) Service Tax = Rs 6.29, Total = Rs 4219.88
79. (a) Rs 3,200 (b) Rs 43,200 (c) Rs 3,456 (d) Rs 46,656
80. (i) 57.55% (ii) 22.65% **81.** Rs 35 **82.** 12.5%
83. Bill amount Rs 582.01 **84.** $882.9 + 3\% = \text{Rs } 909.39$
85. (i) Rs 5,000 (ii) Rs 1,05,000 (iii) Rs 5,250 (iv) Rs 1,10,250
86. Gain 27.08% **87.** Rs 630 **88.** Rs 7,840 **89.** 7305.38
90. Rs 25,000 **91.** 7,00,000 **92.** 0% gain or no profit no loss
93. Petrol 10.96%, Diesel 6.09%, LPG 8.20%
94. A. 42.06% (increase) B. 15.94% (decrease)
C. 83.34% (decrease) D. 8.34% (decrease)
95. 18.027% or 18.03% **96.** Loss = 0.25%
97. 40% **98.** Rs 864 **99.** Rs 3561.60 **100.** 30%
101. Rs 18,400 **102.** Rs 800 **103.** Rs 1653.60, Rs 1620
104. Amount = Rs 10,75,840, Interest = Rs 51,840
105. Amount to be paid = Rs 3798.50
106. (a) (b) 690 mg (c) 120% (d) 3 : 7 **107.** Rs 90

- 108.** At store A the game is less expensive.
- 109.** (a) Rs 30.60 (b) Rs 59.40
- 110.** (a) No 2 method will give a lower price.
 (b) Method 1 : Rs 202.50, Method 2: Rs 190
 (c) Method 1, because in this method actual discount is less.
- 111.** Neelgiri apartments will be cheaper for the first two months by Rs 900.
- 112.** 20% increase is on original amount (if original price is Rs 100 so increased price would be Rs 120) but 20% decrease is on increased amount (i.e. 20% of 120 would be Rs 24), so decreased amount would be $120 - 24 = 96$. Hence decreased price is less than the original amount.
- 113.** 1. 93.3% 2. $\frac{3}{4}$ 3. False, as according to the claim, for $\frac{3}{100}$ affect of UV rays
 1 minute = $33\frac{1}{3}$ SPF
 Affect \neq 30 SPF claim
- 114.** Rs 12,50,000
- 115.** Original price = Rs 3.97 per kg. Reduced Price = Rs 3.38/kg
- 116.** (1) 81.6 (2) 90.4 (3) 85 (4) 84
 (5) 86.67 (6) 82.5 (7) 90 (8) 82
 (9) 86.67 (10) 87 (11) 88.5
- 117.** 91.43%
- 118.** Minakshi must finish greater per cent of homework at home.
- 119.** 36% **120.** 44.4% **121.** 37.52 kg **122.** 4.431 gram
- 123.** He is finding what per cent is 5 of 32.
- 124.** Brand 1 (X) has greater sales tax rate
 Brand 1 : 7.14%
 Brand II (Y) : 4.84%

Unit 10

1. (c) 2. (d) 3. (a) 4. (d) 5. (a) 6. (a)
 7. (a) 8. (d) 9. (d) 10. (b) 11. (c) 12. (a)
 13. (a) 14. (c) 15. (d) 16. (b) 17. directly
 18. inversely 19. direct, directly
 20. inverse, inversely 21. inversely 22. x/y
 23. directly 24. inversely
 25. 16/3h or 5 h 20 mins 26. 300 27. 96
 28. directly 29. constant 30. ab, constant
 31. ratio 32. product 33. directly 34. 9.6 km
 35. $2\frac{1}{4}$ h or 2h 15 mins 36. 90 cm 37. $y = 8$
 38. = 39. $\frac{a_1}{a_2} \frac{b_2}{b_1}$ 40. 480 cm²
 41. 288 hrs 42. 0.250 km 43. False 44. False
 45. False 46. False 47. False 48. False
 49. True 50. False 51. False 52. False
 53. False 54. True 55. True 56. False
 57. False 58. True 59. True
 60. (i) Inversely (ii) Direct (iii) Inverse (iv) Direct
 (v) Direct
 61. (i) Direct (ii) Direct (iii) Direct (iv) Direct
 (v) Neither
 62. (i) Direct (ii) Neither (iii) Inverse (iv) Direct
 (v) Direct
 63. $y = 30$ 64. $x = 128$ 65. $l = 40$ 66. $x = 20$
 67. $39\frac{3}{8}$ 68. 448 person 69. 540 words 70. 96 km/h
 71. (i) $\frac{l}{m}k$ (ii) $k = \frac{1}{3}$ (iii) $l = 11$ (iv) $m = 24$
 72. Rs 9,000 73. 8.75 cm 74. $x = 72, y = 45$
 75. 280 m 76. 60l 77. (i) No (ii) Yes (iii) Yes

- 78.** (i) $27/2 = p$, $36/13 = q$, $108/25 = r$
 (ii) $x = 45$, $y = 7.2$, $z = 9$
 (iii) $l = 12$, $m = 20/3$, $n = 12/5$
- 79.** (i) Rs 540 (ii) 60 m **80.** 12 pumps **81.** Rs 4,800
- 82.** 9 m **83.** 25 days
- 84.** (i) mixture A, (ii) mixture D, (iii) mixture F, (iv) mixture G
 Lightest blue shade in mixture D.
 30 containers of blue colours
 75 containers of white colours
- 85.** Purple (=12), Blue (=20), White (=16)
 Total = $12 + 20 + 16 = 48$
 Statement I : P : Total = $12 : 48 = 1 : 4$
 Statement II : B : Total = $20 : 48 = 5 : 12$
 Statement III : W : Total = $16 : 48 = 1 : 3$
 Statement IV : P : B : = $12 : 20 = 3 : 5$
 Statement IV : P : W : = $12 : 16 = 3 : 4$
- 86.** 5 sweets **87.** 11 cows **88.** 21 person **89.** 5 km
- 90.** 9.00 A.M.
- 91.** 1 - H, 2 - D, 3 - G, 4 - F
- 5 - C6 - A 7 - B 8 - E
- 92.** 60 g **93.** 35 km **94.** 24.9 m $\therefore \frac{x}{21} = \frac{9.5}{8}$
- 95.** Slowest elevator C (speed 13 m/sec)
 Fastest elevator D (speed 17m/sec)
 For elevator B, D distance = 2.29 km
 For elevator C, D distance = 1.820 km
- 96.** 37.5 m **97.** 5 cups **98.** Yes, $k = 1/4$
- 99.** 0.6 secs **100.** p%
- 101.** (a) 10 : 7 (b) 98 black keys (c) 7 : 17
- 102.** Direct proportion, 120 km.

- 103.** 1/2 cup quick cooking gas
 1/6 cup bread flour
 1/6 cup sugar syrup
 1/2 tablespoon cooking oil
 2/3 cup water
 3/2 tablespoons yeast
 1/2 tea spoon salt

104. 8 new teachers

105. 125 miles

106. (a) Rs 425, (b) 480 posts

Across

- 1 Directly
 4 Unitary
 5 Less
 7 Proportion
 9 Decrease

Down

- 2 Inverse
 3 Equivalent
 6 Constant
 7 Product
 8 Increases

Unit 11

- 1.** (c) **2.** (c) **3.** (b) **4.** (a) **5.** (b) **6.** (c)
7. (d) **8.** (a) **9.** (b) **10.** (c) **11.** (c) **12.** (d)
13. (c) **14.** (c) **15.** (a) **16.** (b) **17.** (c) **18.** (d)
19. (c) **20.** (c) **21.** (a) **22.** (a) **23.** (c) **24.** (a)
25. (c) **26.** (a) **27.** (c) **28.** (c) **29.** 24 **30.** None
- 31.** $10a^2$ **32.** 4 times **33.** $h^3, 6h^2$ **34.** $\frac{1}{4}$
- 35.** 50% **36.** $\frac{\pi}{4}a^3$ **37.** πb^2 **38.** $\frac{1}{2}(h_1 + h_2)d$
- 39.** Two times **40.** 3 **41.** rectangular, different
- 42.** equal **43.** $2\pi rh$ **44.** $2\pi rh(h+r)$
- 45.** $\pi r^2 h$ **46.** Diagonals **47.** Twice **48.** Equal
- 49.** Volume **50.** Lateral **51.** 3 : 1 **52.** 36 : 1
- 53.** True **54.** False **55.** False **56.** False
- 57.** False **58.** True **59.** False **60.** False
- 61.** False **62.** $\frac{1}{2}$ min or 30 sec. **63.** 15 m

- 64.** $1,050 \text{ m}^2$ **65.** Rs 528
66. (1) 352.8 m^2 , 468.3 m^2 (2) 106.3 m^2 , 102.80 m^2
 (3) 13.35 m^2 , 235.6 m^2
67. 10 m **68.** 26 min 24 sec **69.** 7 : 8
70. 84 m **71.** 302 m **72.** 32.4 cm **73.** 0.636 km
74. 0.264 km/hr **75.** 13 m **76.** 53000 sq. units
77. 30100 sq. units **78.** 432 m^2 **79.** 240 m^2
80. 600 m^2 **81.** 13046 cm^2 **82.** 72 cm^2 **83.** 199.5 cm^2
84. 228.85 cm^2 **85.** 88.28 cm^2

86. (a) $\frac{x^3}{2}$ (b) $6y^3$ **87.** 1 : 5 **88.** 1 : 2π

89. 43.12 m^3 **90.** $r = 21 \text{ cm}$, $h = 14 \text{ cm}$
91. $V = 11440 \text{ cm}^3$, Weight = 91520 g
92. (a) double of the original (b) Half of the original
 (c) One fourth of the original **93.** 27 times the original
94. $h = 20 \text{ cm}$ **95.** 13280 cm^2 **96.** 22.68 m^3 , 22680 l
97. 64 cubes **98.** 6752 cm^3 **99.** $45,000 \text{ m}^3$
100. 1390.72 cm^2 **101.** 0.78 m
102. 42038.857 **103.** 1400 cm^2 **104.** B Pipe **105.** 200 m^3
106. 1 day **107.** 1440 **108.** 1848 cm^2
109. 25 dm, 20 dm, 15 dm **110.** $r = 0.07 \text{ m}$, 0.44 m^2

111. (a) 27 times (b) $\frac{1}{64}$ times **112.** $V = 3850 \text{ cm}^3$, $A = 110 \text{ cm}^2$
113. 445000 cm^2 , = 44.55 l **114.** $r = 8 \text{ cm}$, $A = 603.428 \text{ cm}^2$
115. 11180400 cm^2 , 11.180400 cm^2 **116.** 621600 l
117. 1000 **118.** $h = 8 \text{ m}$, $b = 10 \text{ m}$
119. 1 : 1 **120.** 6500 cm^3 **121.** 3 cm^2
122. 2016 cm^2 **123.** 2042 **124.** 401.2 cm^2
125. 70 cm **126.** 5082 cm^3 , 3811.5 cm^3

Unit 12

1. b 2. d 3. b 4. c 5. c 6. a
 7. d 8. c 9. c 10. d 11. line graph
 12. graph 13. pair of 14. y -axis 15. x -axis y -axis
 16. plotting 17. x 18. x -axis 19. 2 20. zero
 21. 4 22. x -coordinate/abscissa 23. (5, 4)
 24. y -coordinate/ordinate 25. origin 26. True 27. True
 28. False 29. False 30. False 31. True 32. True 33. False
 34. True 35. (1) d, (2) f, (3) e, (4) a, (5) b, (6) c
 36. (a) ii (b) iii (c) i (d) v (e) vi (f) iv
 37. (a) F (2, 0) (b) A (0, 4) (c) H (5, 1) (d) C (2, 6) (e) E (3, 3)
 38. A (0, 7.5) B (4, 5) C (7.5, 2.5) D (11, 0) E (14.5, 6.5)
 F (18, 9.5)
 40. (a) (A, f) (b) (monkeys, elephants) (c) (o, e) (d) (c, c)
 41. (a) 7, (b) 5, 90 42. (a) 5 (b) 0 (c) 7
 43. (a) Yes (b) No, square (c) No, triangle
 44. x 1 2 3 4
 y 3 6 9 12 46. (a) Rs 70, (b) 5
 47. (a) Uniform speed.
 (b) Moves with uniform speed then comes to rest.
 (c) Moves with non-uniform speed then slowly comes to rest.

48. (a)

x	0	1	2	3
y	1	4	7	10

(b)

x	0	2	4	6
y	-1	1	3	5

49. (a)

x	0	1	2	3
y	0	1	2	3

(b)

x	0	1	2	3
y	2	4	6	8

50. (a) 264 unit (b) $r = 35$ unit

51. (a) Maximum temp. in $^{\circ}\text{C}$ in the two consecutive weeks.

(b) First week (c) Wednesday (d) Friday

(e) 1st week - 37°C , 2nd week - 33°C

(f) Sunday (g) Wednesday

52. (a) April (b) March (c) April (d) 250 (e) 125 (f) $2/3$

53. (a) Subjects marks obtained (out of 10) by Sania in two terms exams in class VIII.

(b) Maths (c) English & Maths

(d) English & Hindi (e) 6 (f) Same in boths (g) Test I Maths

54. (A) (1, 1) E (5, 1) I (4,4)
 (B) (3, 0) F (6, 3) J (4, 5)
 (C) (4, 2) G (5,5) K (3, 6)
 (D) (2, 3) H (4, 3) L (2, 6)
 (M) (1, 5) O (2, 4) Q (0, 5)
 (N) (2, 5) P (1, 2)

55. (a) 10 am (b) 16 km (c) not travelling

(d) 40 km (e) 24 km (f) 2 pm

(g) 4 km/h, 0 km/h (h) 10 p.m.

56. (a) $p = 6$ (b) $q = 4$

57. (a) Maximum temp is 31°C in a week

(b) Sunday, 25°C (c) Wednesday

(d) Friday

58. (a) 240 km (b) 5 hours (c) 2 hours (d) 120 km

(e) Time and Distance graph

- (f) P after 1 hour
 R after 5 hours
 Q after 3 hours
 S after 6 hours
- 59.** D (4, 4) **60.** D (3, 0) No **61.** (2, 2)
- 62.** (a) Vendor A (b) Sunday (c) Saturday to Sunday
 (d) Thursday (e) Tuesday & Wednesday
- 63.** (a) 7°C (b) 6 a.m. (c) 3°C
 (d) between 8 am to 9 am (e) between 8 am to 9 am
- 64.** (a) 90 cm (b) 20 cm more (c) between 4 yrs to 6 yrs
- 65.** Sneha made least progress between 25 minutes to 40 minutes
- 66.** (a) E (0.5, 0.5) J (2, 1.5)
 F (2, 2) K (8, 6)
 G (4, 2) L (16, 6)
 H (2.5, 0.5) M (10, 1.5)
- 68.** (a) 0 - 20 sec. (b) 30 sec. (c) nearly 20°C
 (d) It reaches 100°C at 50 sec. which is the maximum.
- 69.** (a) line graph
 (b) It represents the no. of people who visited a store at a particular time.
 (c) 1 p.m. (d) less than 5 (e) 20
- 70.** (a) 5.30 a.m. and ends at 6 p.m. (b) 12:30 hours
 (c) forward (d) 3 hours
- 71.** (a) 8:45 am for 15 minutes (b) faster (c) at 9.00 a.m.
 (d) 10 km. (e) 10 km.
- 72.** Graph 15 km. **73.** Graph
- 74.** (a) 18 years, 17 years, (b) boys
- 75.** (a) Time and distance
 (c) 0 to 5 minutes and 5 to 10 minutes

MATHEMATICS

76.

x	1	2	3	4	5
y	1.25	5	10	15	20

77. (a) highest 1990, lowest 2000 (b) 1996 (c) 4.7%

78. (a) pattern 1 2 3 4 5 6
toothpicks 4 7 10 13 16 19

(b) graph (c) pattern $y = 3x + 1$

(d)

x	7	8
y	22	25

(e) Yes

79. (a) $y = 3x - 1$

(b)

x	3	8
y	8	23

80. 1. Water, No 2. No. C (7, 5) D (5, 7) 3. (2, 7)
4. (6, 11) 5. (7, 3) (5, 5) 6. (7.5, 3) 2 km
7. (8.5, 3) 8. (6.25, 3)
9. (9, 4) (10, 4) (11, 5) 10. (7, 8) (8, 8) (9, 8) 11. (5, 3) (6, 2) (7, 2)

81. a) Makes it easy to understand the temp. change
b) Temp. increases up to 1:00 p.m. and then decreases
c) at 12 pm $19^{\circ}\text{C}.$, at 8 pm $10^{\circ}\text{C}.$

82. a) E and F b) D c) B and F, C and E
d) C, D, E e) Yes f) A g) A and C

83. (a) Height and Weight
(b) D - Ostrich B - Donkey A - Crocodile C - Dog

84. a) True b) True c) True
d) True e) False

85. Side length of purple S 1 2 3 4 5 10 100

White Tiles b 4 8 12 16 20 40 400

(c) $b = 45$

86. Rows r 4 6 8

White Tiles 9 15 21

Purple Tiles 1 6 15

Activity

- | | | |
|----------------|----------------|-----------------|
| 1. Bar graph | 2. y -axis | 3. Linear graph |
| 4. Origin | 5. Coordinates | 6. Right |
| 7. Abcissa | 8. Axes | 9. Graph |
| 10. Cartesia | 11. Line | 12. Ordinate |
| 13. Whole | 14. Histogram | 15. Gaps |
| 16. Horizontal | 17. x -axis | |

Unit 13

- 1.** (c) **2.** (b) **3.** (c) **4.** (c) **5.** (c) **6.** (c)
7. (d) **8.** (b) **9.** (a) **10.** (d) **11.** (b) **12.** (a)
13. (c) **14.** (a) **15.** (c) **16.** (a) **17.** (b) **18.** 9
19. 1, 4, 7 **20.** 1 **21.** 11 **22.** 9 **23.** 11
24. $A = 6, B = 3$ **25.** $A = 2, B = 4$ (four) **26.** $B = 7$ **27.** $x = 0$
28. $a + c$ or $12(a + c)$ **29.** 11 **30.** $(a + c) - b$ **31.** 5
32. values, $A = 3, B = 6$ **33.** $t41$ **34.** True **35.** False **36.** False
37. True **38.** True **39.** True **40.** True **41.** False **42.** True
43. False **44.** False **45.** $a = 3$ **46.** $P = 6$ and $Q = 9$ **47.** 12
48. 33033, 66066, 99099 **49.** $A = 9, Z = 8, X = 1$
50. $A = 8, B = 1, C = 3$ **51.** $A = 6, B = 7, C = 1$ **52.** $A = 6, B = 9$.
53. $A = 5, B = 6, C = 7$ **54.** $A = 9, B = 1$ **55.** $A = 8, B = 9$
56. $A = 7, B = 8, C = 4$ **57.** $A = 2, B = 5$ **58.** $A = 9, B = 1, C = 8$

MATHEMATICS

- 59.** $A = 7, B = 2$ **60.** $A = 7, B = 2, C = 3, D = 1$ **61.** $A = 9$
62. $X = 8$ **63.** k is either 0 or 3, 6, 9 **64.** $y = 5$ **65.** $x = 8$
66. 2 **67.** $S = 8, L = 5, M = 9, G = 1$ **68.** $S = 6, M = 9, B = 1, U = 0$
69. 96, 85, 74, 63, 52, 41, 30
70. (a) 5555555555 (b) 7777777777 (c) 72 (d) 81
71. (i) $P = 7, Q = 4$ (ii) $M = 7, L = 4$ **72.** $B = 4$ **73.** $A = 4$
74. Least value of y is 0

Cross Number Puzzle

- | | |
|-------|-------|
| (A) 7 | (F) 4 |
| (B) 0 | (G) 8 |
| (C) 4 | (H) 9 |
| (D) 2 | (I) 1 |
| (E) 0 | (J) 0 |

Activity

- 3, 5, 9
- 2, 3, 6, 9
- 2, 5, 10
- 2, 3, 6, 9, 11
- 2, 4, 8